

Probability >= 99%  
99% > Probability >= 95%  
95% > Probability >= 90%  
90% > Probability >= 80%  
80% > Probability >= 70%  
70% > Probability >= 60%  
60% > Probability >= 50%  
50% > Probability

ENERGY = -593.3 23

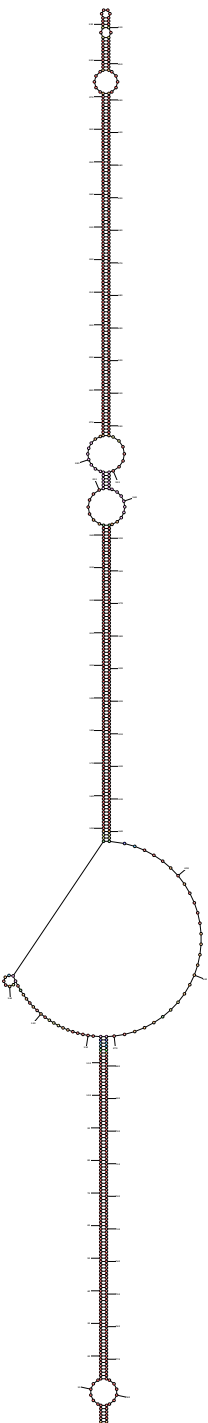

Probability >= 99%  
99% > Probability >= 95%  
95% > Probability >= 90%  
90% > Probability >= 80%  
80% > Probability >= 70%  
70% > Probability >= 60%  
60% > Probability >= 50%  
50% > Probability

ENERGY = -592.7 23

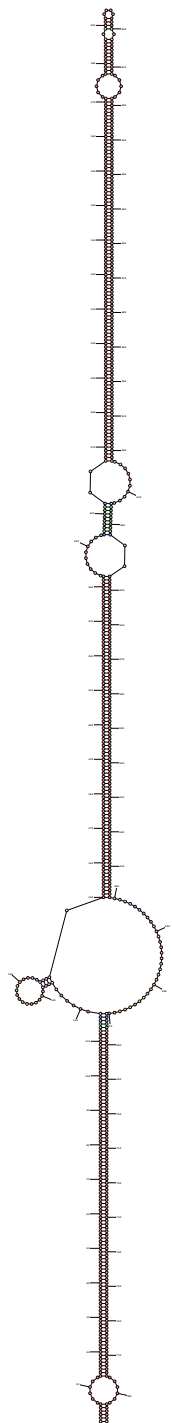

Probability >= 99%  
99% > Probability >= 95%  
95% > Probability >= 90%  
90% > Probability >= 80%  
80% > Probability >= 70%  
70% > Probability >= 60%  
60% > Probability >= 50%  
50% > Probability

ENERGY = -592.0 23

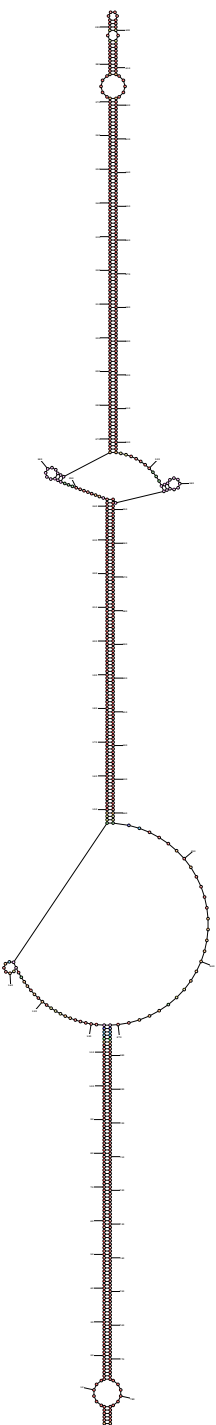

Probability >= 99%  
99% > Probability >= 95%  
95% > Probability >= 90%  
90% > Probability >= 80%  
80% > Probability >= 70%  
70% > Probability >= 60%  
60% > Probability >= 50%  
50% > Probability

ENERGY = -588.2 23

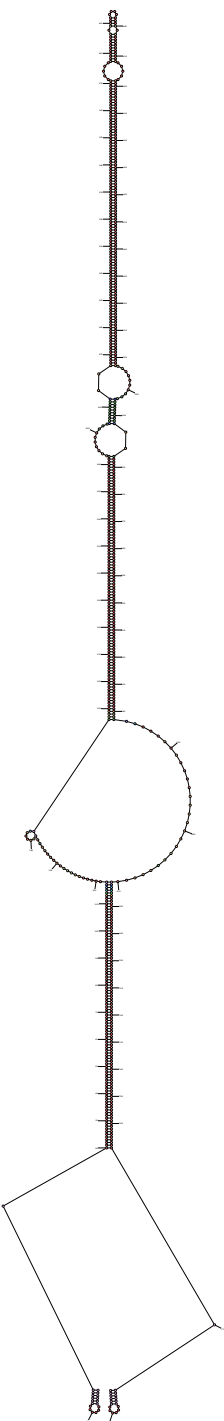

Probability >= 99%

99% > Probability >= 95%

95% > Probability >= 90%

90% > Probability >= 80%

80% > Probability >= 70%

70% > Probability >= 60%

60% > Probability >= 50%

50% > Probability

ENERGY = -587.4 23

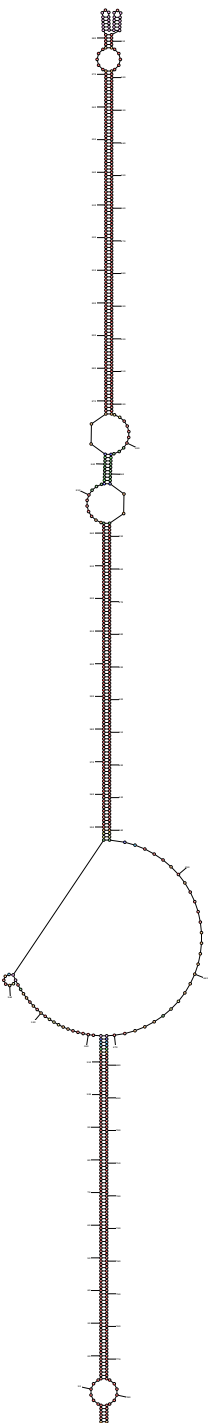

Probability >= 99%  
99% > Probability >= 95%  
95% > Probability >= 90%  
90% > Probability >= 80%  
80% > Probability >= 70%  
70% > Probability >= 60%  
60% > Probability >= 50%  
50% > Probability

ENERGY = -584.9 23

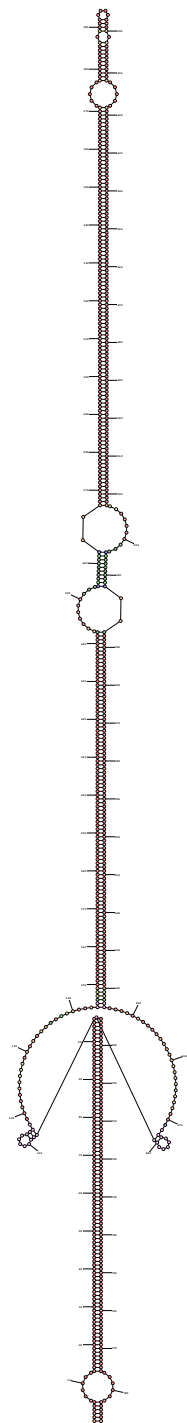

Probability >= 99%  
99% > Probability >= 95%  
95% > Probability >= 90%  
90% > Probability >= 80%  
80% > Probability >= 70%  
70% > Probability >= 60%  
60% > Probability >= 50%  
50% > Probability

ENERGY = -582.9 23

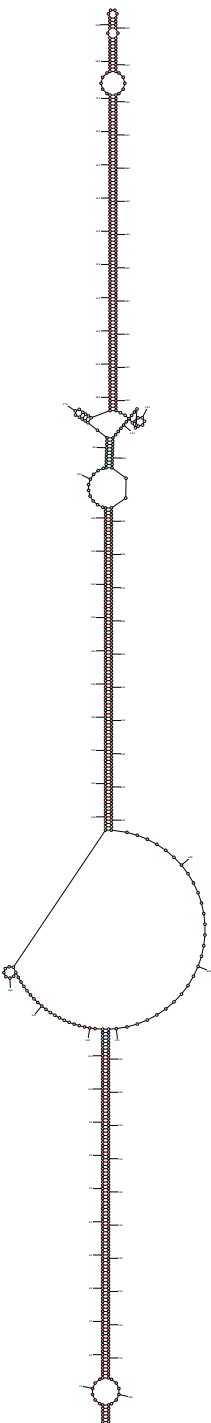

Probability >= 99%  
99% > Probability >= 95%  
95% > Probability >= 90%  
90% > Probability >= 80%  
80% > Probability >= 70%  
70% > Probability >= 60%  
60% > Probability >= 50%  
50% > Probability

ENERGY = -574.2 23

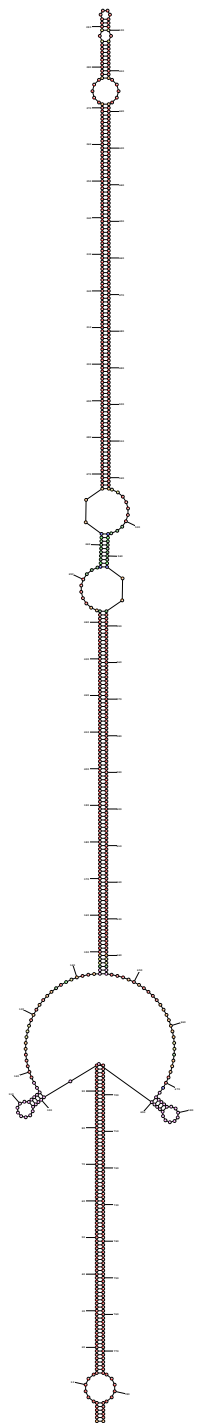

Probability >= 99%  
99% > Probability >= 95%  
95% > Probability >= 90%  
90% > Probability >= 80%  
80% > Probability >= 70%  
70% > Probability >= 60%  
60% > Probability >= 50%  
50% > Probability

ENERGY = -574.1 23

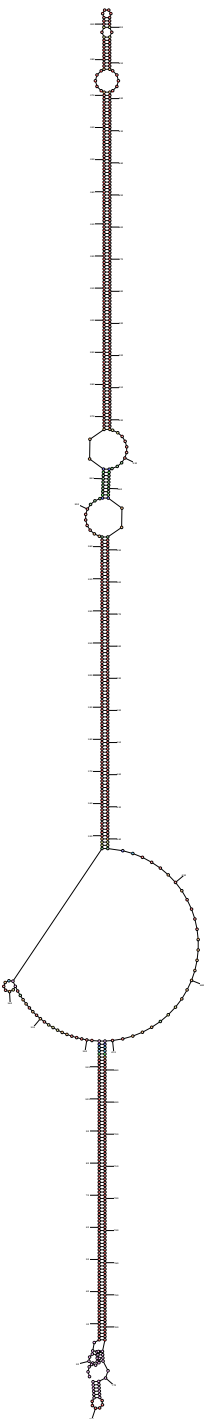

Probability >= 99%  
99% > Probability >= 95%  
95% > Probability >= 90%  
90% > Probability >= 80%  
80% > Probability >= 70%  
70% > Probability >= 60%  
60% > Probability >= 50%  
50% > Probability

ENERGY = -567.8 23

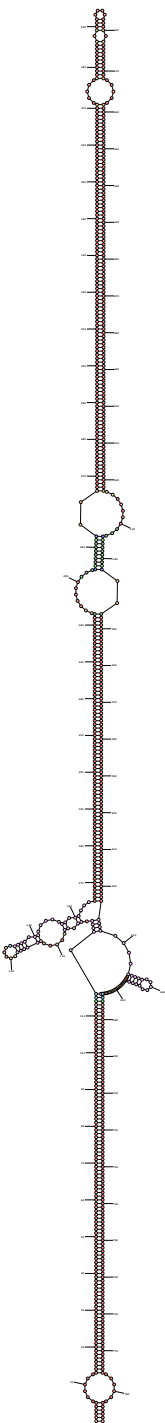

Probability >= 99%  
99% > Probability >= 95%  
95% > Probability >= 90%  
90% > Probability >= 80%  
80% > Probability >= 70%  
70% > Probability >= 60%  
60% > Probability >= 50%  
50% > Probability

ENERGY = -563.6 23

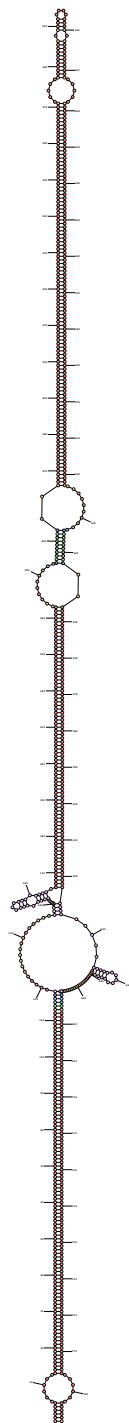

Probability >= 99%  
99% > Probability >= 95%  
95% > Probability >= 90%  
90% > Probability >= 80%  
80% > Probability >= 70%  
70% > Probability >= 60%  
60% > Probability >= 50%  
50% > Probability

ENERGY = -562.7 23

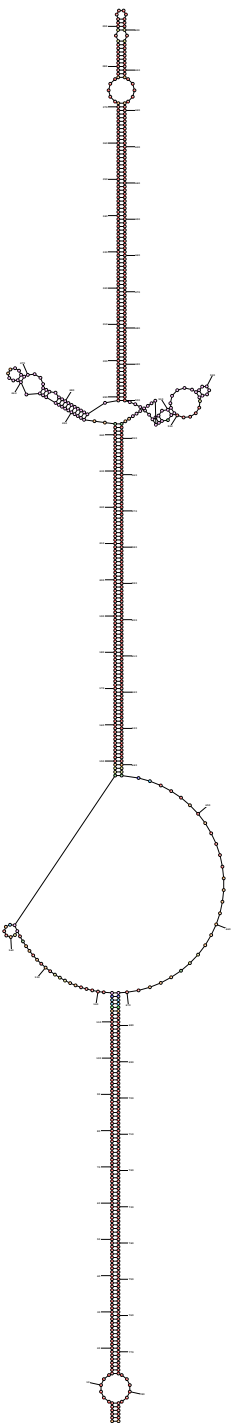

Probability >= 99%  
99% > Probability >= 95%  
95% > Probability >= 90%  
90% > Probability >= 80%  
80% > Probability >= 70%  
70% > Probability >= 60%  
60% > Probability >= 50%  
50% > Probability

ENERGY = -556.0 23

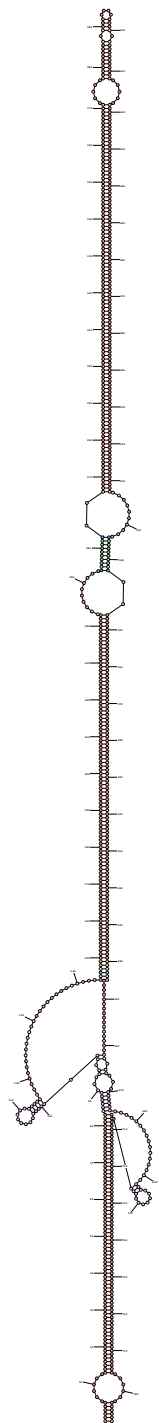

Probability >= 99%  
99% > Probability >= 95%  
95% > Probability >= 90%  
90% > Probability >= 80%  
80% > Probability >= 70%  
70% > Probability >= 60%  
60% > Probability >= 50%  
50% > Probability

ENERGY = -554.0 23

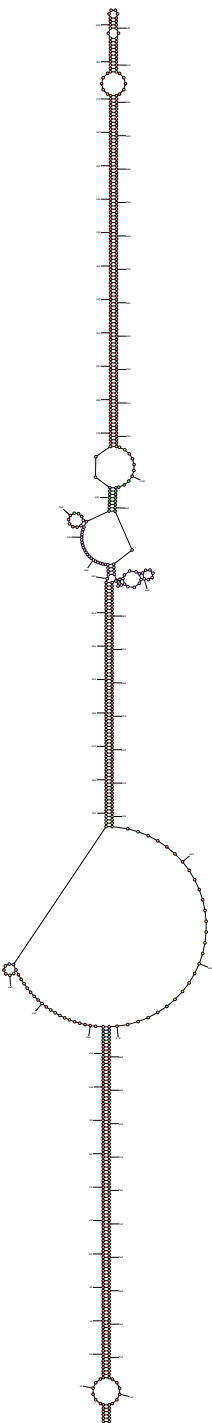

Probability >= 99%  
99% > Probability >= 95%  
95% > Probability >= 90%  
90% > Probability >= 80%  
80% > Probability >= 70%  
70% > Probability >= 60%  
60% > Probability >= 50%  
50% > Probability

ENERGY = -548.1 23

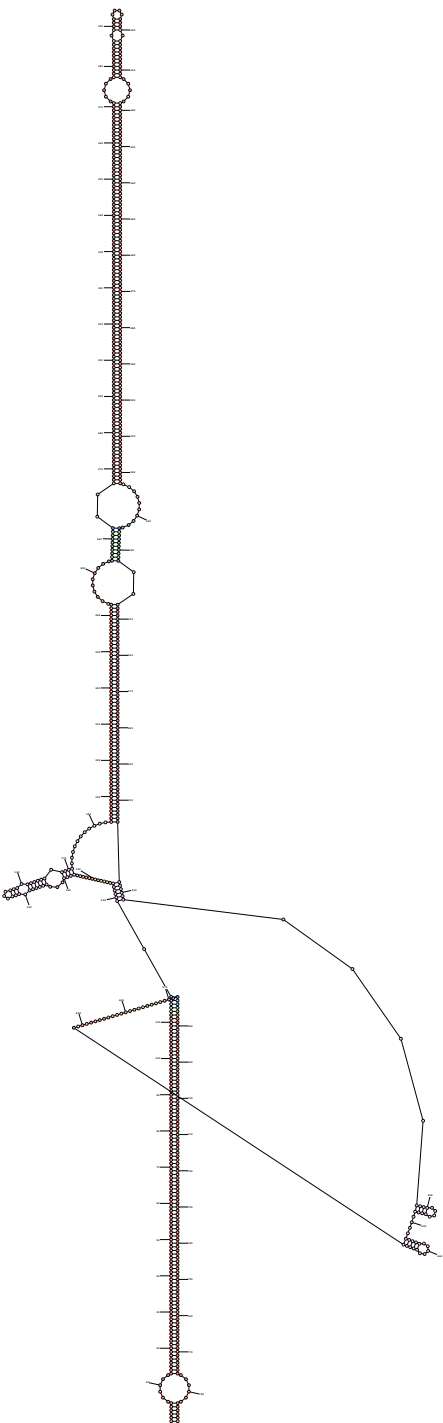

Probability >= 99%  
99% > Probability >= 95%  
95% > Probability >= 90%  
90% > Probability >= 80%  
80% > Probability >= 70%  
70% > Probability >= 60%  
60% > Probability >= 50%  
50% > Probability

ENERGY = -545.5 23

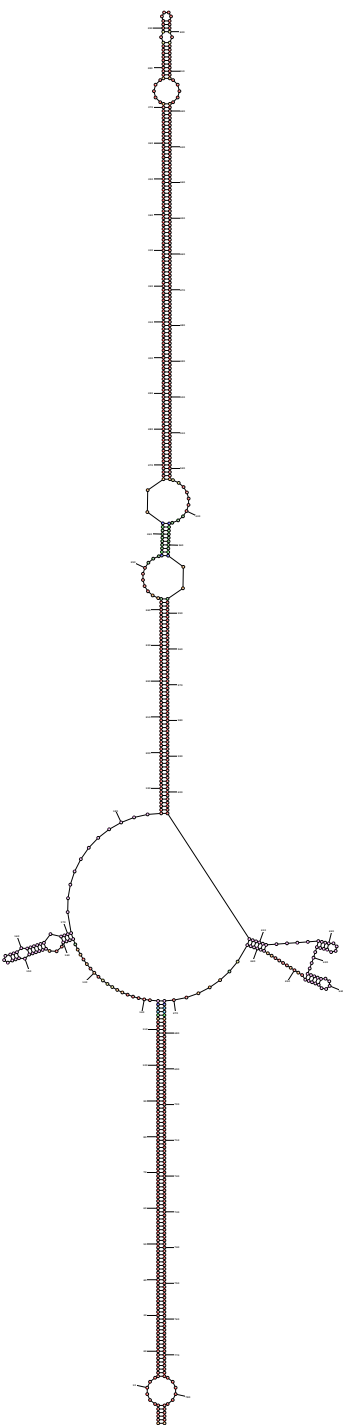

Probability >= 99%  
99% > Probability >= 95%  
95% > Probability >= 90%  
90% > Probability >= 80%  
80% > Probability >= 70%  
70% > Probability >= 60%  
60% > Probability >= 50%  
50% > Probability

ENERGY = -544.7 23

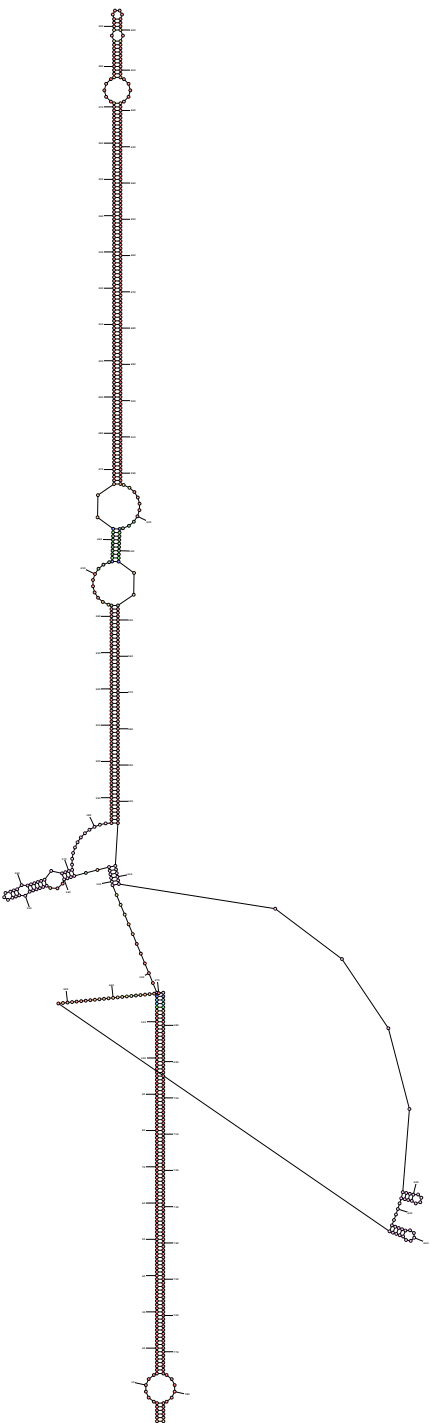

Probability >= 99%  
99% > Probability >= 95%  
95% > Probability >= 90%  
90% > Probability >= 80%  
80% > Probability >= 70%  
70% > Probability >= 60%  
60% > Probability >= 50%  
50% > Probability

ENERGY = -544.7 23

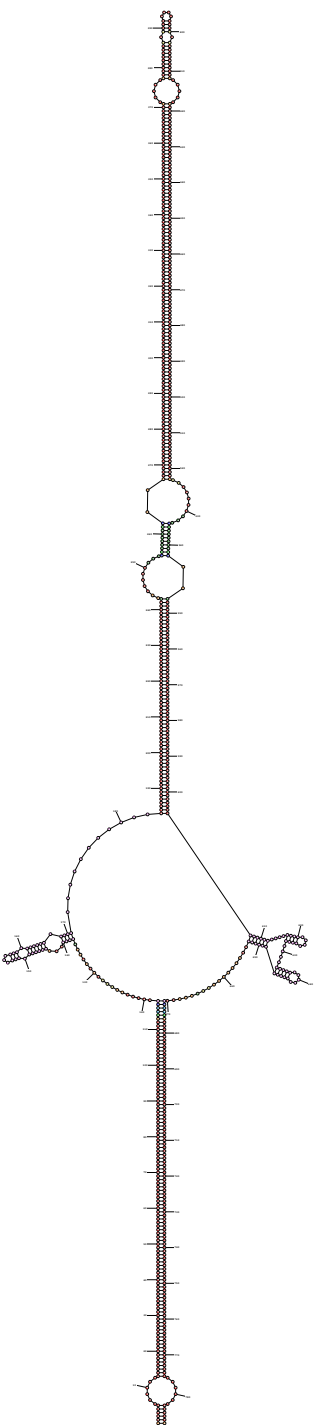

Probability >= 99%  
99% > Probability >= 95%  
95% > Probability >= 90%  
90% > Probability >= 80%  
80% > Probability >= 70%  
70% > Probability >= 60%  
60% > Probability >= 50%  
50% > Probability

ENERGY = -544.4 23

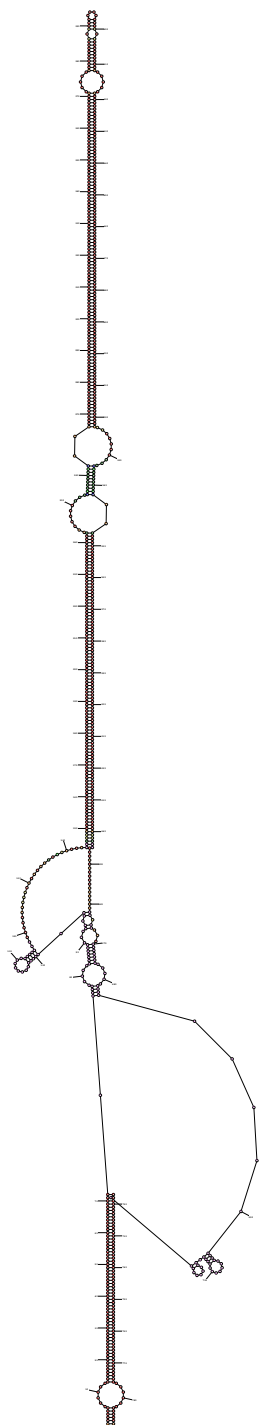

Probability >= 99%

99% > Probability >= 95%

95% > Probability >= 90%

90% > Probability >= 80%

80% > Probability >= 70%

70% > Probability >= 60%

60% > Probability >= 50%

50% > Probability

ENERGY = -541.7 23