

**Probability >= 99%**  
**99% > Probability >= 95%**  
**95% > Probability >= 90%**  
**90% > Probability >= 80%**  
**80% > Probability >= 70%**  
**70% > Probability >= 60%**  
**60% > Probability >= 50%**  
**50% > Probability**

**ENERGY = -132.3 03/24/26 10:25:20**

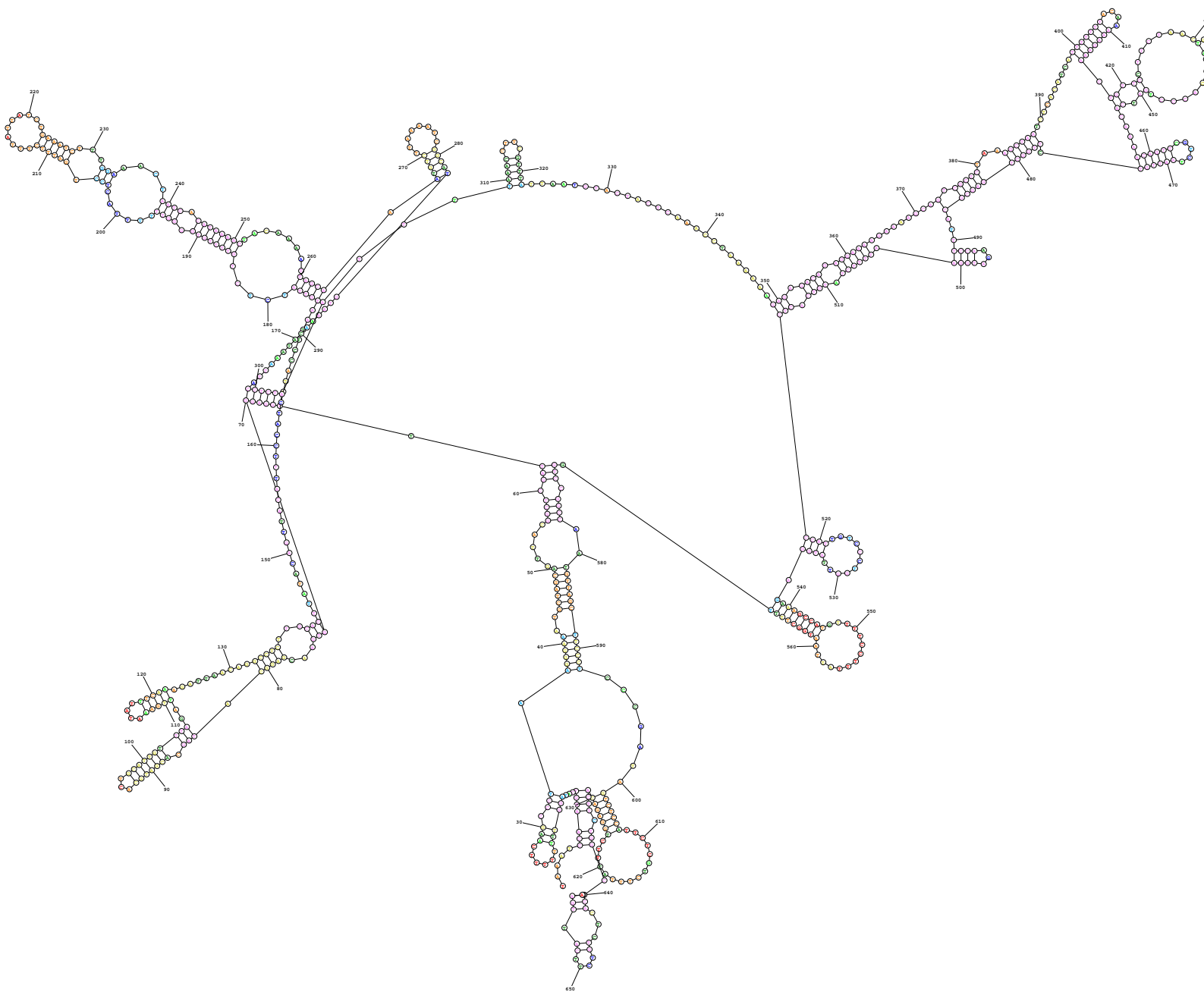

**Probability >= 99%**  
**99% > Probability >= 95%**  
**95% > Probability >= 90%**  
**90% > Probability >= 80%**  
**80% > Probability >= 70%**  
**70% > Probability >= 60%**  
**60% > Probability >= 50%**  
**50% > Probability**

**ENERGY = -132.2 03/24/26 10:25:20**

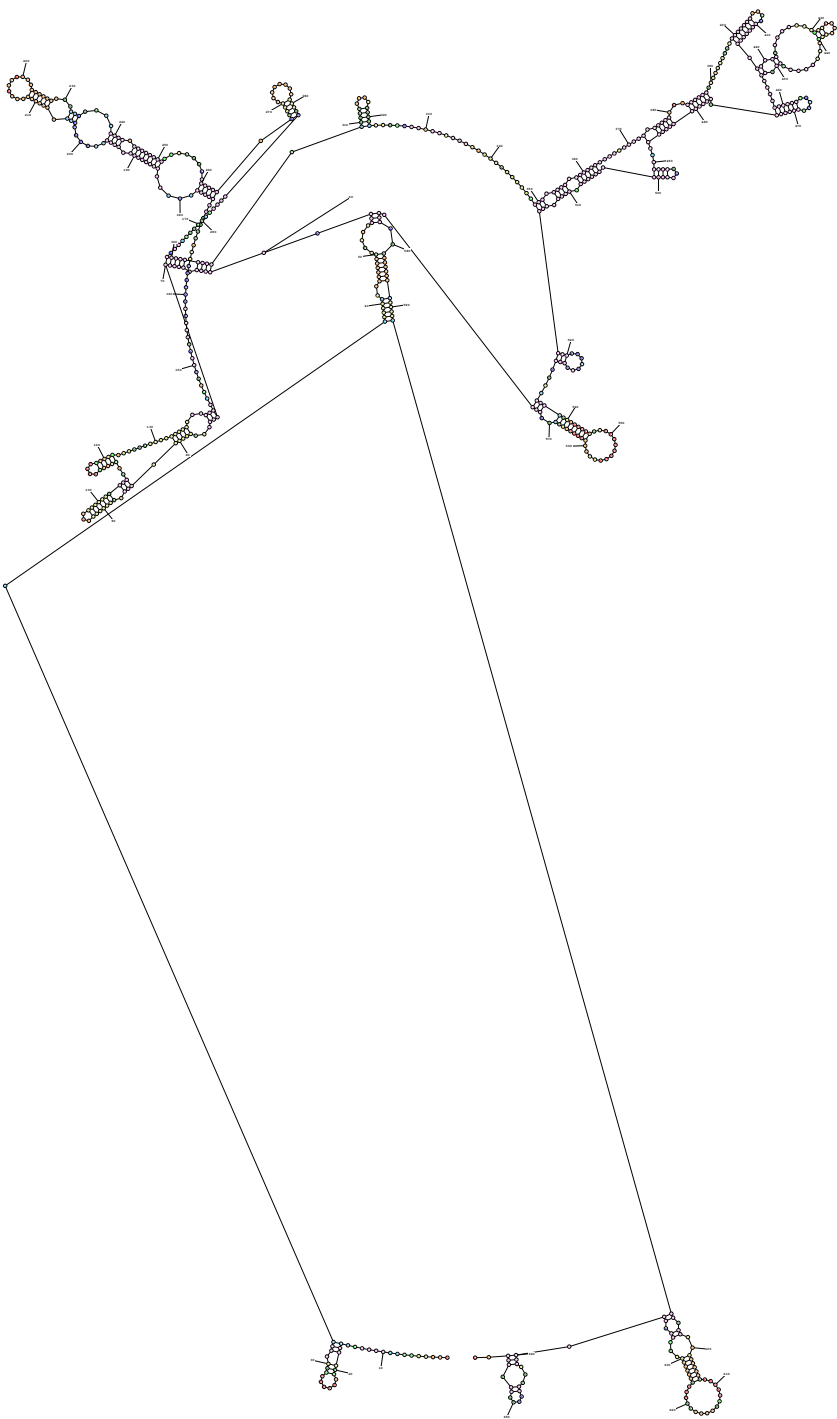

**Probability >= 99%**  
**99% > Probability >= 95%**  
**95% > Probability >= 90%**  
**90% > Probability >= 80%**  
**80% > Probability >= 70%**  
**70% > Probability >= 60%**  
**60% > Probability >= 50%**  
**50% > Probability**

**ENERGY = -132.1 03/24/26 10:25:20**

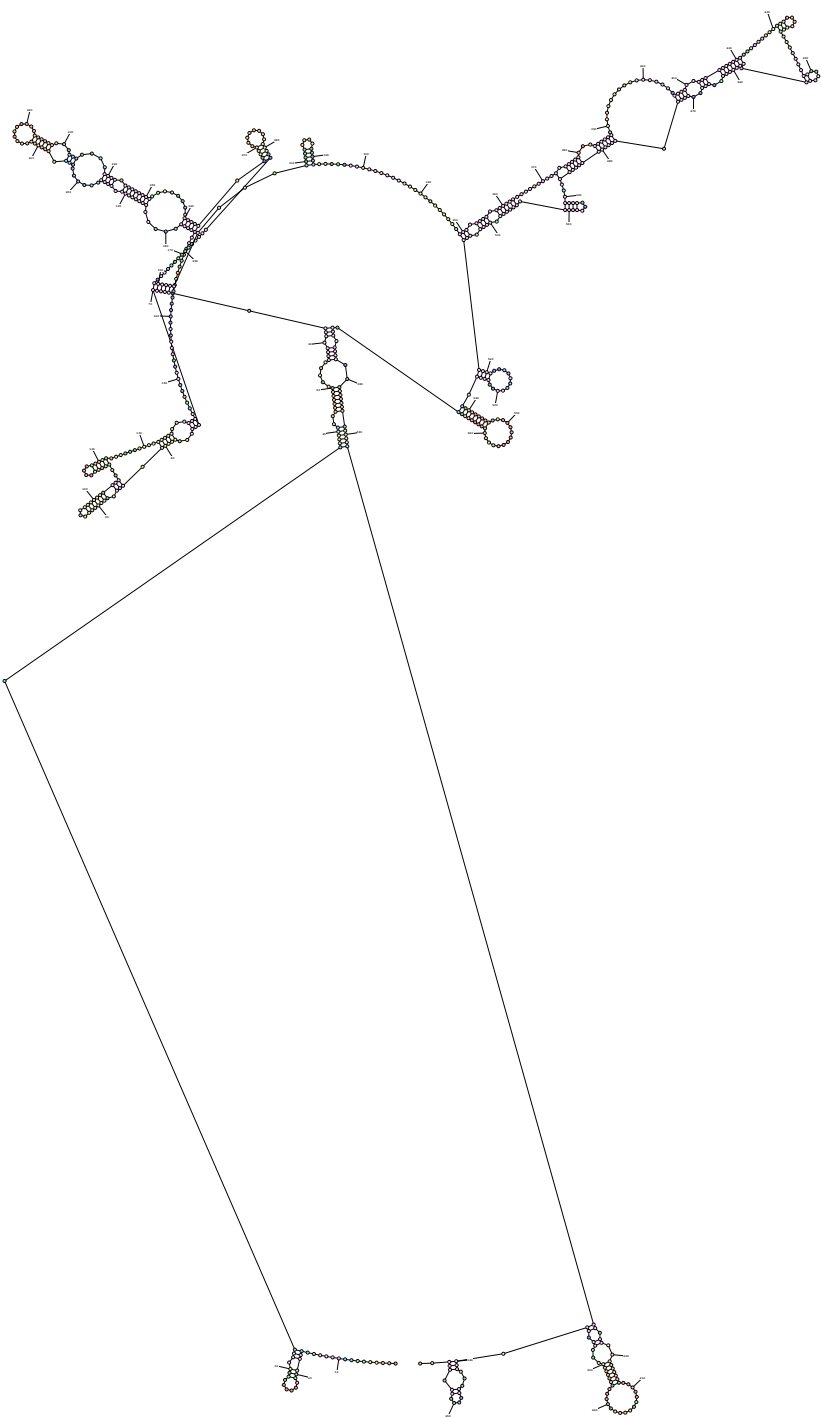

Probability >= 99%  
99% > Probability >= 95%  
95% > Probability >= 90%  
90% > Probability >= 80%  
80% > Probability >= 70%  
70% > Probability >= 60%  
60% > Probability >= 50%  
50% > Probability

ENERGY = -131.9 03/24/26 10:25:20

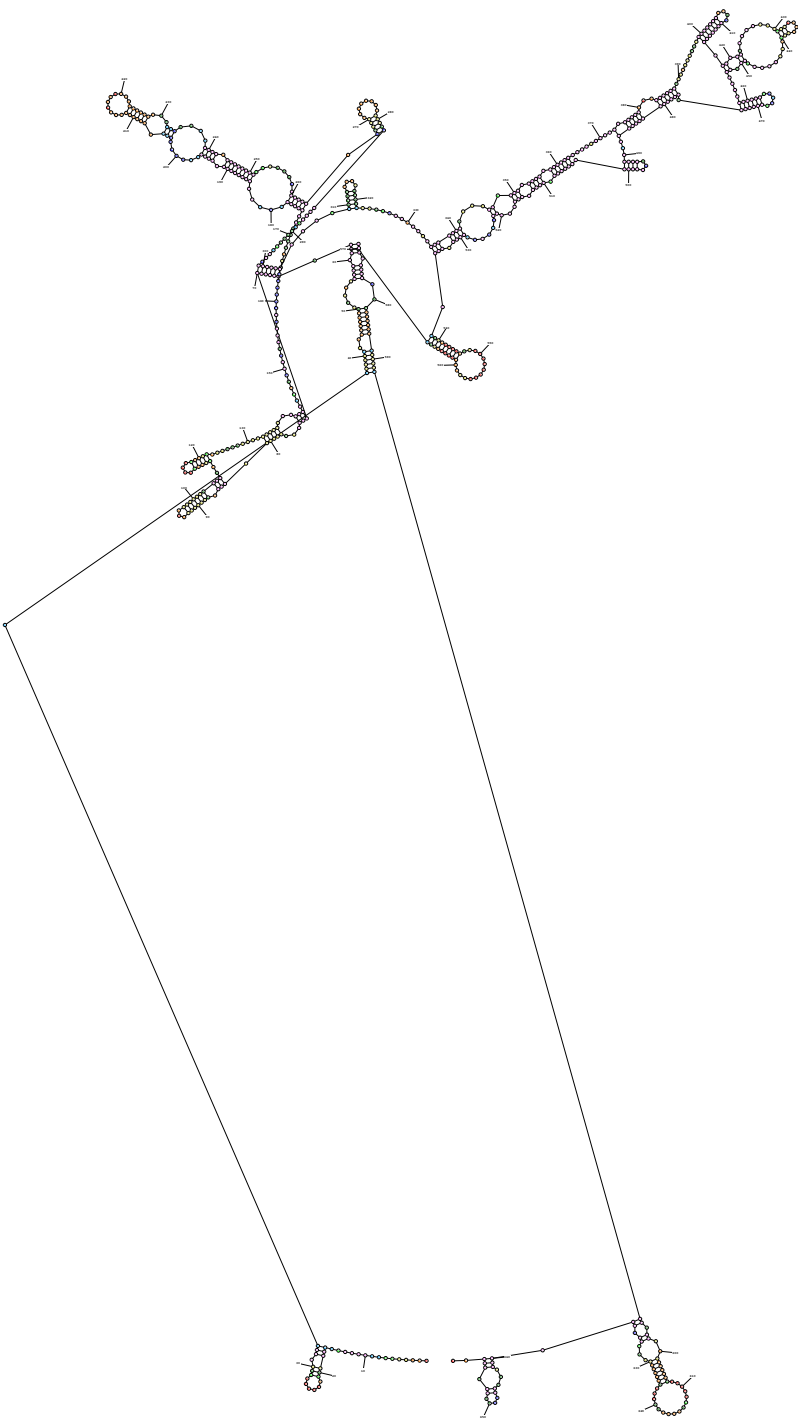

**Probability >= 99%**  
**99% > Probability >= 95%**  
**95% > Probability >= 90%**  
**90% > Probability >= 80%**  
**80% > Probability >= 70%**  
**70% > Probability >= 60%**  
**60% > Probability >= 50%**  
**50% > Probability**

**ENERGY = -131.8 03/24/26 10:25:20**

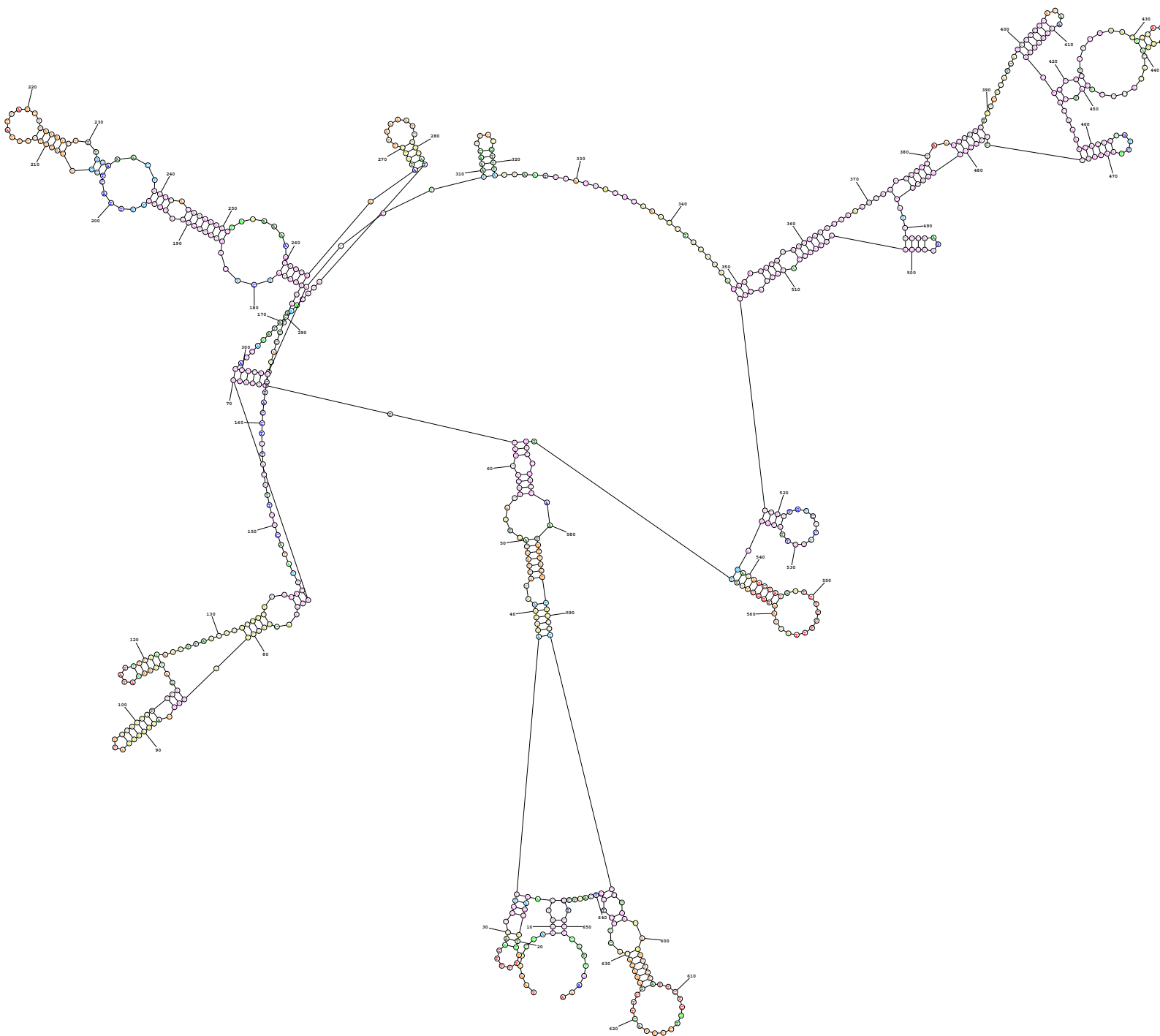

**Probability  $\geq$  99%**

**99% > Probability  $\geq$  95%**

**95% > Probability  $\geq$  90%**

**90% > Probability  $\geq$  80%**

**80% > Probability  $\geq$  70%**

**70% > Probability  $\geq$  60%**

**60% > Probability  $\geq$  50%**

**50% > Probability**

**ENERGY = -131.7 03/24/26 10:25:20**

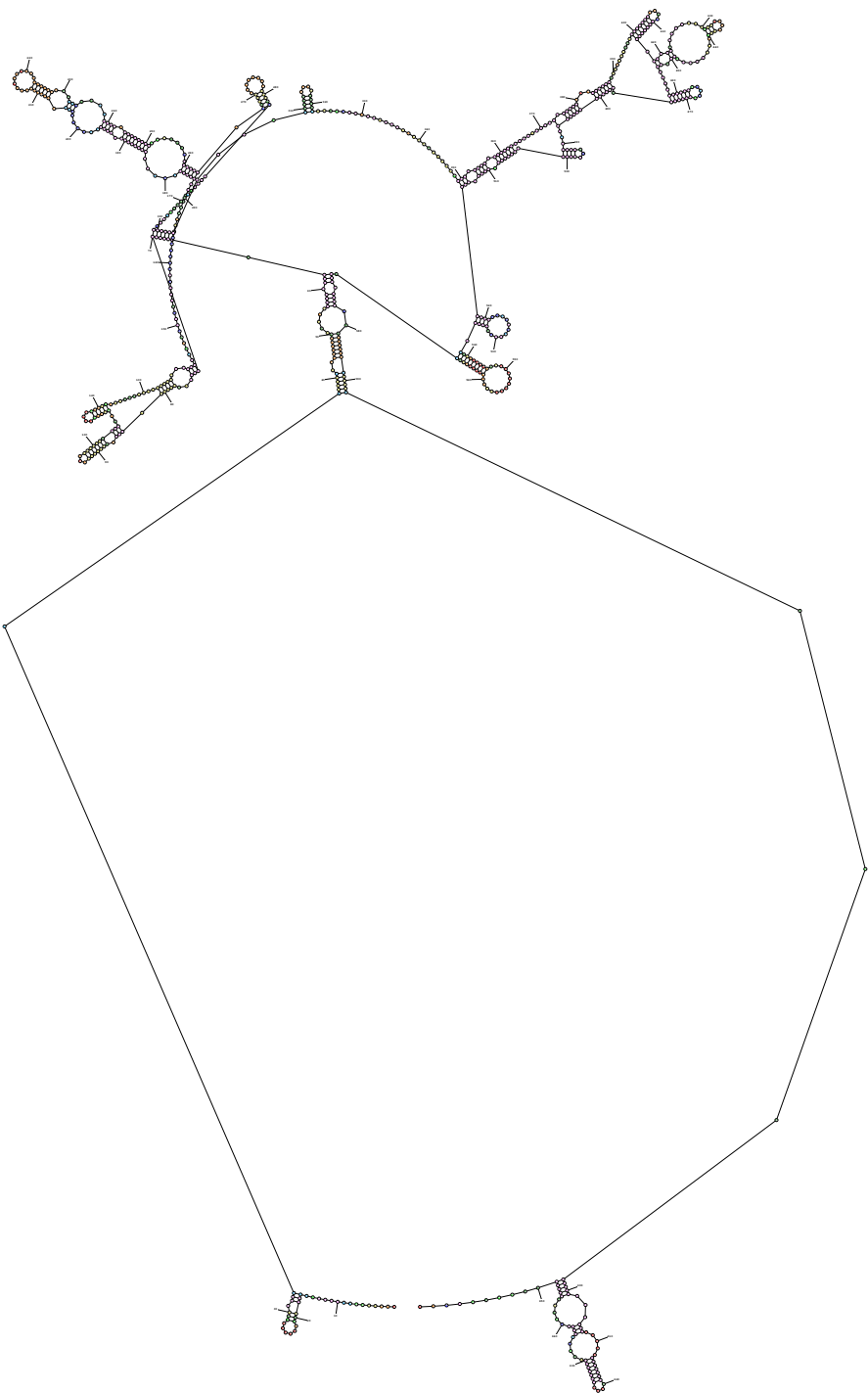

**Probability >= 99%**  
**99% > Probability >= 95%**  
**95% > Probability >= 90%**  
**90% > Probability >= 80%**  
**80% > Probability >= 70%**  
**70% > Probability >= 60%**  
**60% > Probability >= 50%**  
**50% > Probability**

**ENERGY = -131.7 03/24/26 10:25:20**

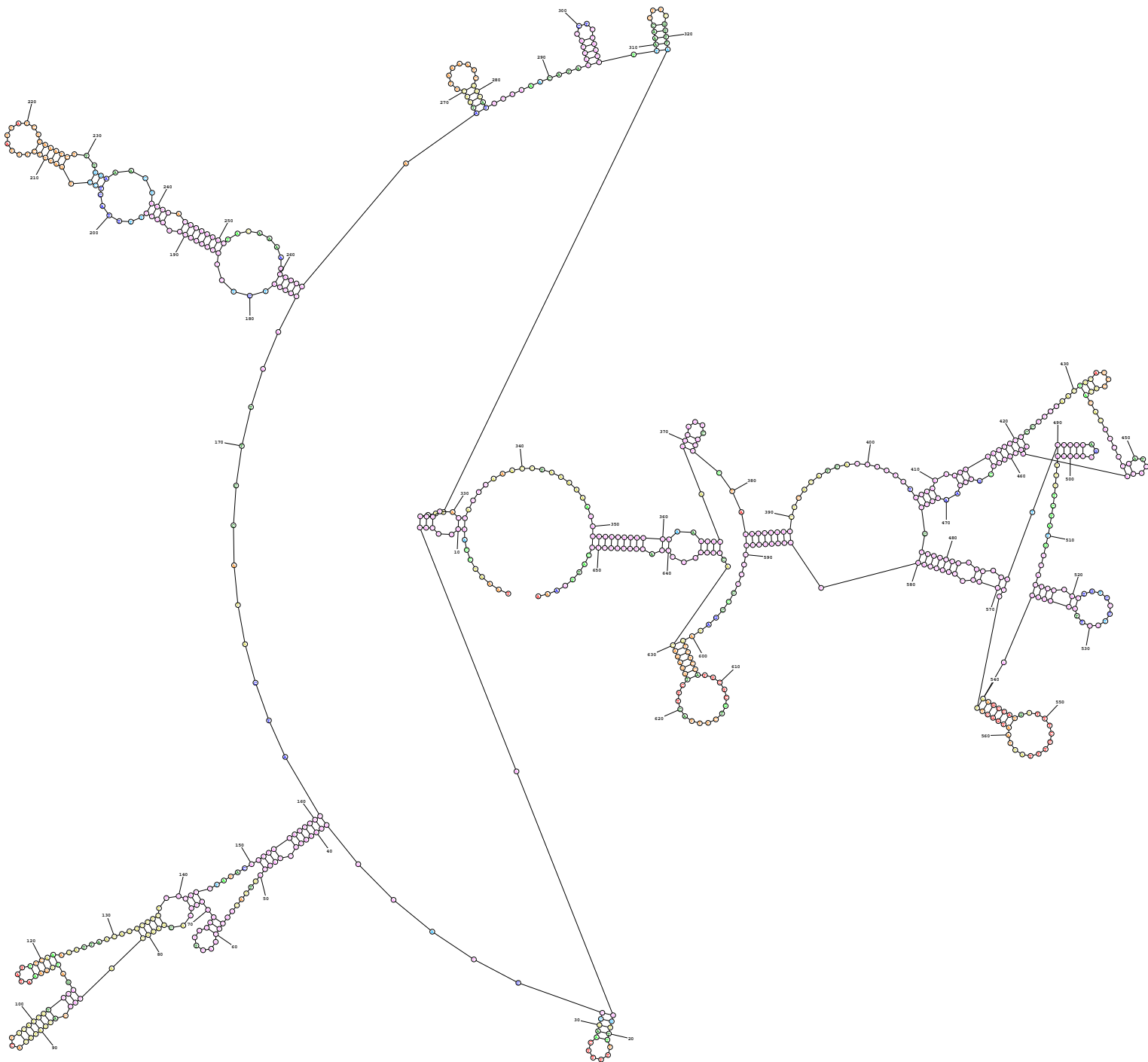

**Probability >= 99%**

**99% > Probability >= 95%**

**95% > Probability >= 90%**

**90% > Probability >= 80%**

**80% > Probability >= 70%**

**70% > Probability >= 60%**

**60% > Probability >= 50%**

**50% > Probability**

**ENERGY = -131.6 03/24/26 10:25:20**

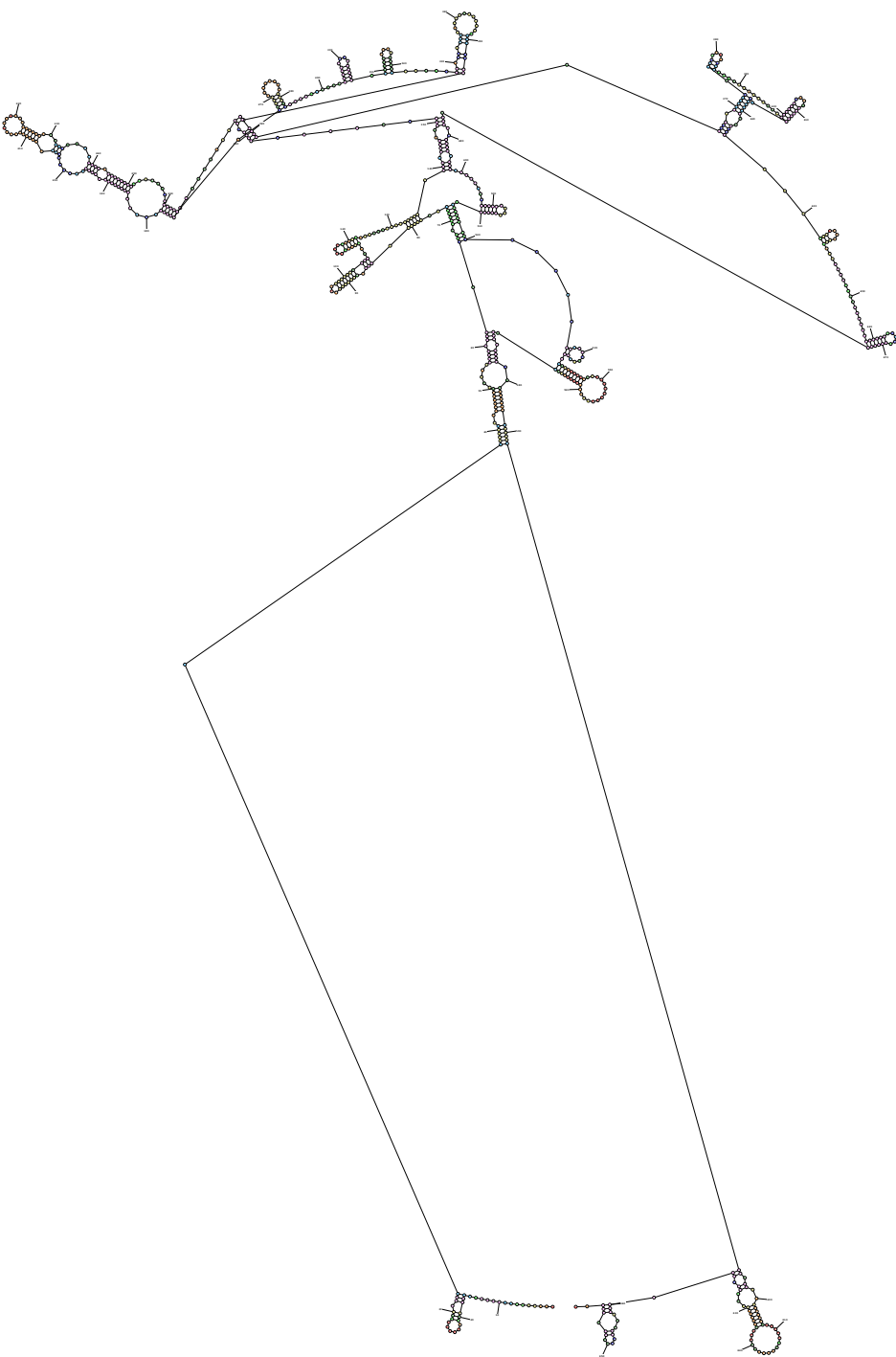

**Probability >= 99%**  
**99% > Probability >= 95%**  
**95% > Probability >= 90%**  
**90% > Probability >= 80%**  
**80% > Probability >= 70%**  
**70% > Probability >= 60%**  
**60% > Probability >= 50%**  
**50% > Probability**

**ENERGY = -131.6 03/24/26 10:25:20**

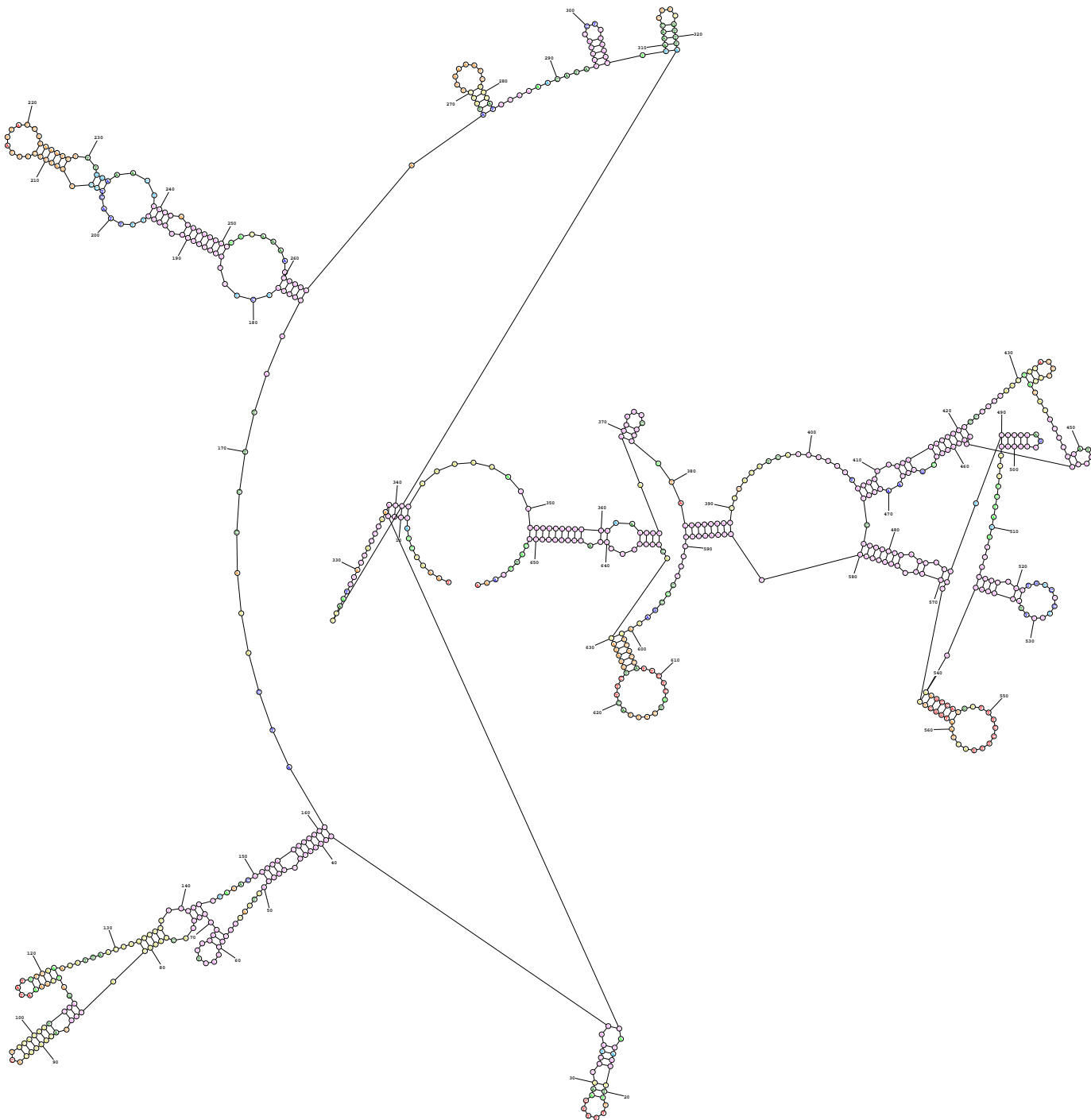

**Probability >= 99%**

**99% > Probability >= 95%**

**95% > Probability >= 90%**

**90% > Probability >= 80%**

**80% > Probability >= 70%**

**70% > Probability >= 60%**

**60% > Probability >= 50%**

**50% > Probability**

**ENERGY = -131.6 03/24/26 10:25:20**

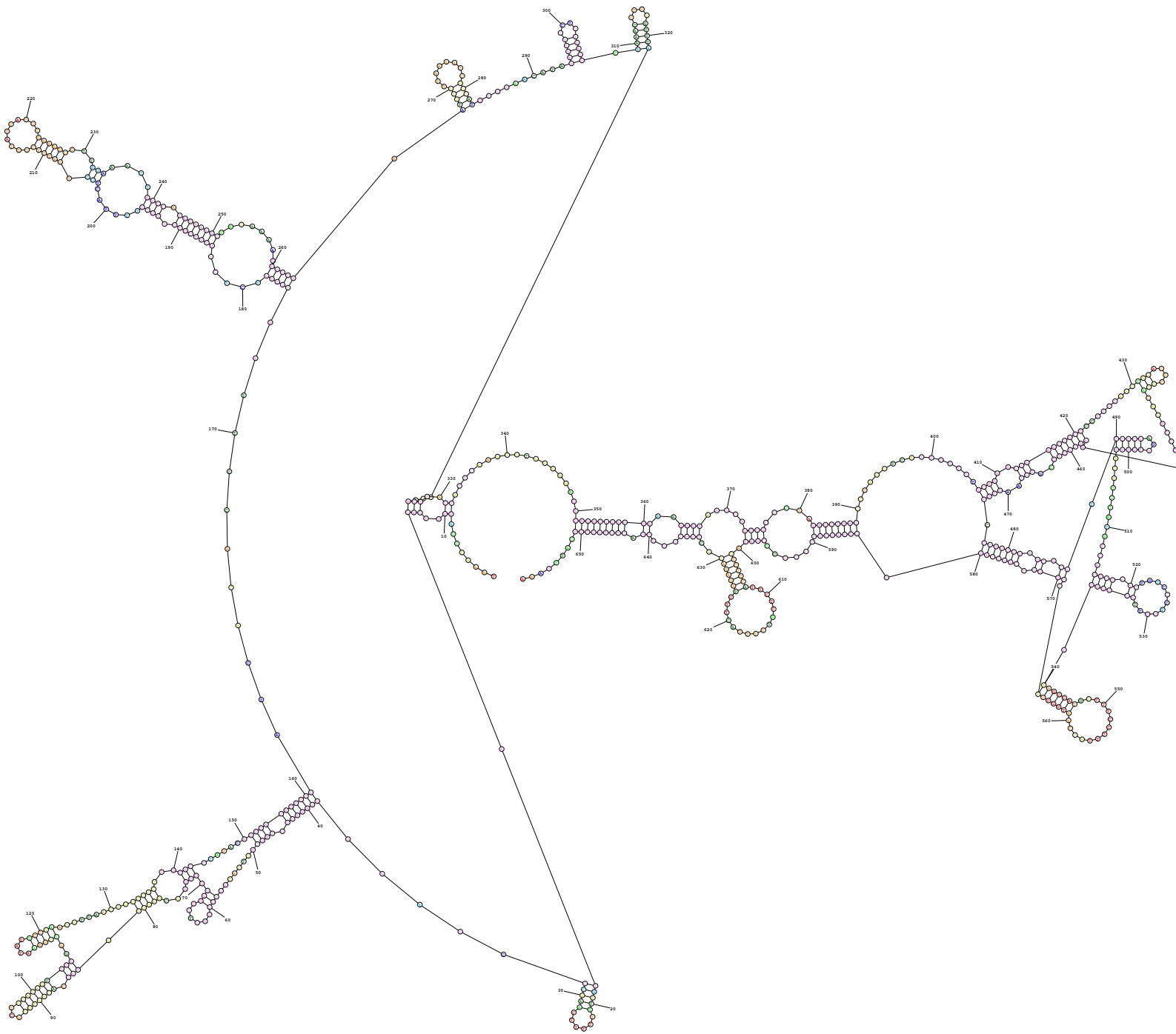

**Probability >= 99%**

**99% > Probability >= 95%**

**95% > Probability >= 90%**

**90% > Probability >= 80%**

**80% > Probability >= 70%**

**70% > Probability >= 60%**

**60% > Probability >= 50%**

**50% > Probability**

**ENERGY = -131.5 03/24/26 10:25:20**

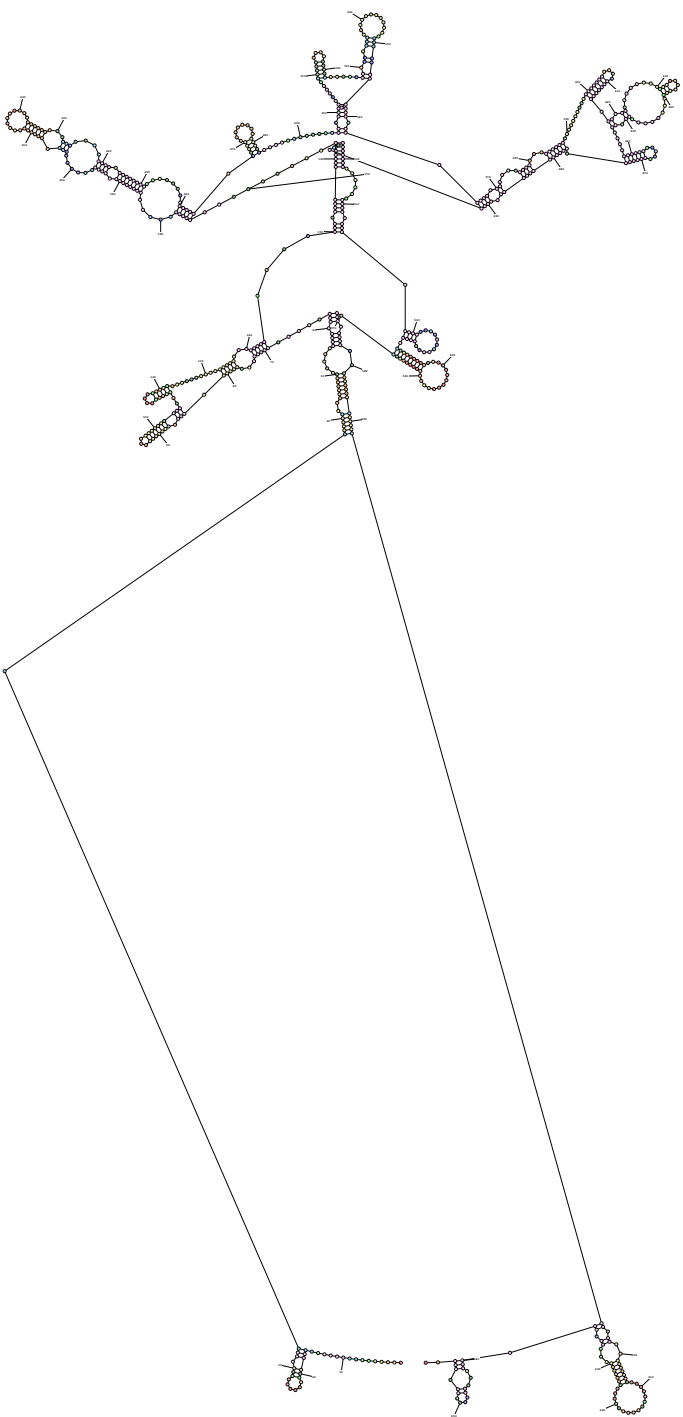

**Probability >= 99%**  
**99% > Probability >= 95%**  
**95% > Probability >= 90%**  
**90% > Probability >= 80%**  
**80% > Probability >= 70%**  
**70% > Probability >= 60%**  
**60% > Probability >= 50%**  
**50% > Probability**

**ENERGY = -131.3 03/24/26 10:25:20**

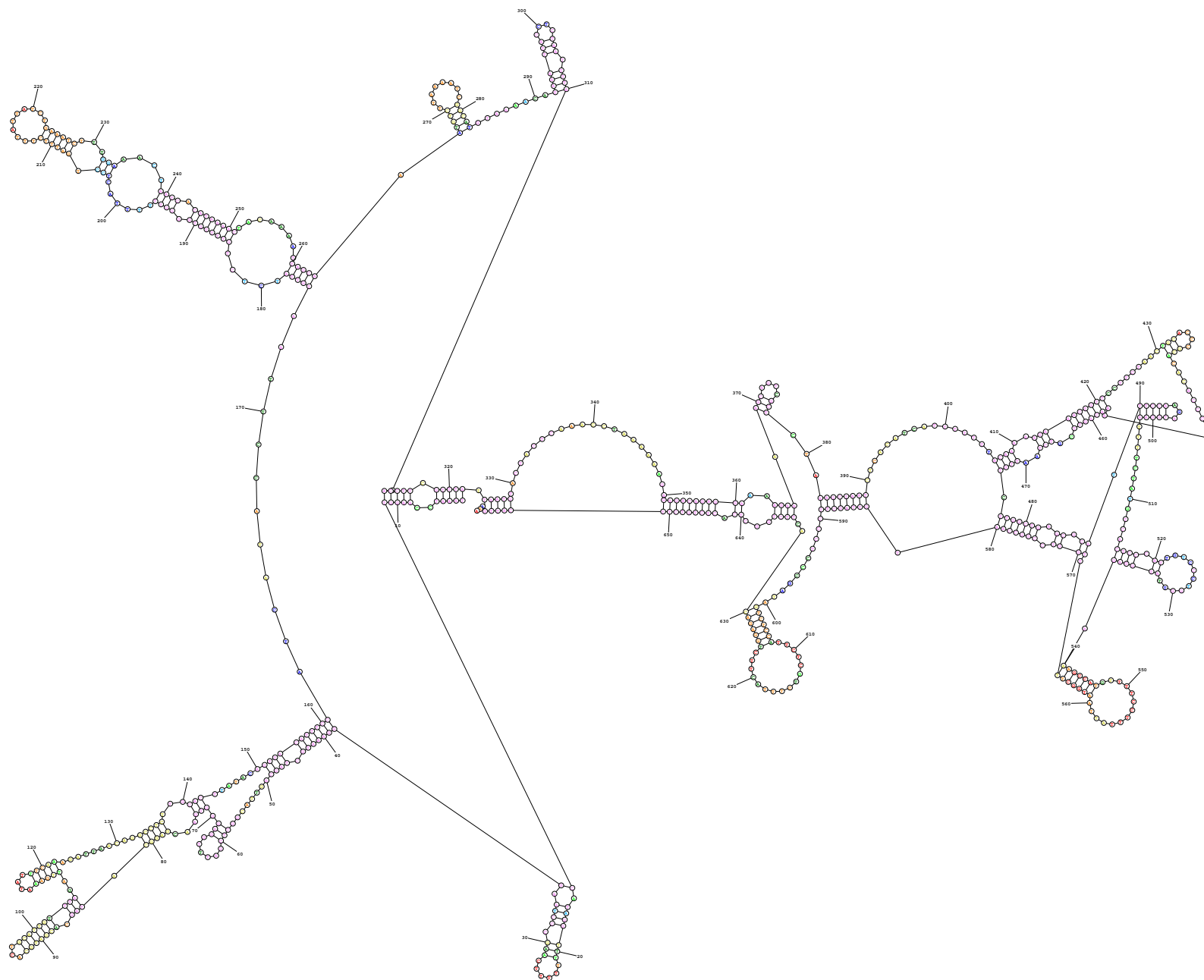

**Probability >= 99%**

**99% > Probability >= 95%**

**95% > Probability >= 90%**

**90% > Probability >= 80%**

**80% > Probability >= 70%**

**70% > Probability >= 60%**

**60% > Probability >= 50%**

**50% > Probability**

**ENERGY = -131.3 03/24/26 10:25:20**

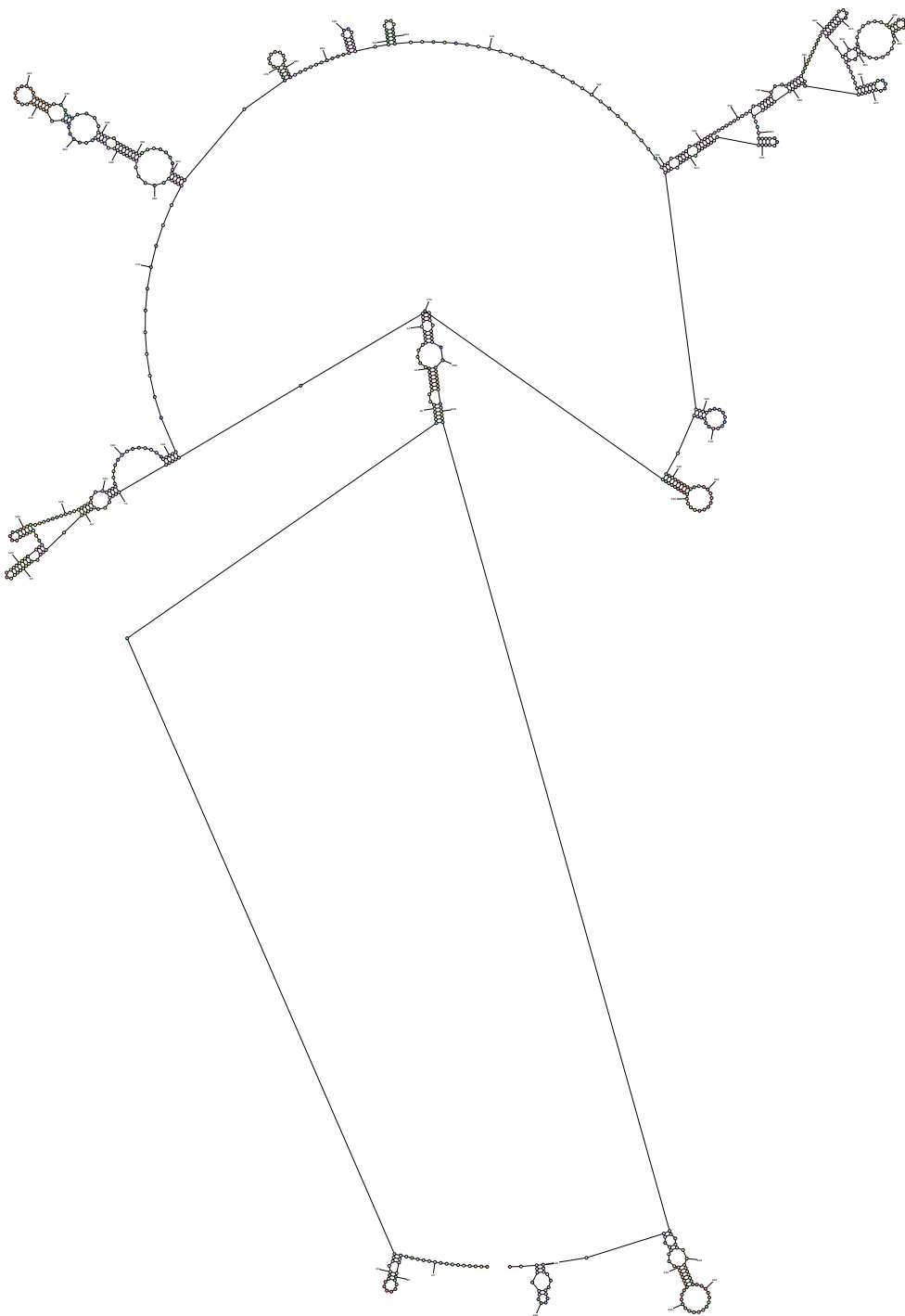

**Probability >= 99%**  
**99% > Probability >= 95%**  
**95% > Probability >= 90%**  
**90% > Probability >= 80%**  
**80% > Probability >= 70%**  
**70% > Probability >= 60%**  
**60% > Probability >= 50%**  
**50% > Probability**

**ENERGY = -131.3 03/24/26 10:25:20**

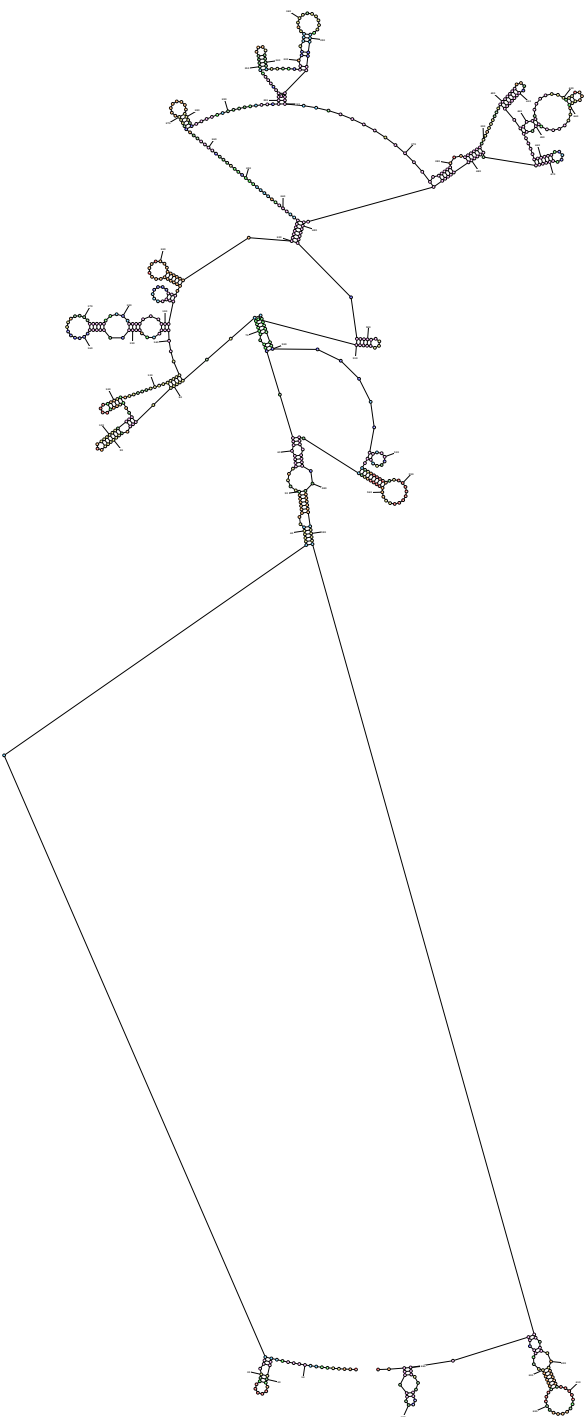

**Probability >= 99%**  
**99% > Probability >= 95%**  
**95% > Probability >= 90%**  
**90% > Probability >= 80%**  
**80% > Probability >= 70%**  
**70% > Probability >= 60%**  
**60% > Probability >= 50%**  
**50% > Probability**

**ENERGY = -131.2 03/24/26 10:25:20**

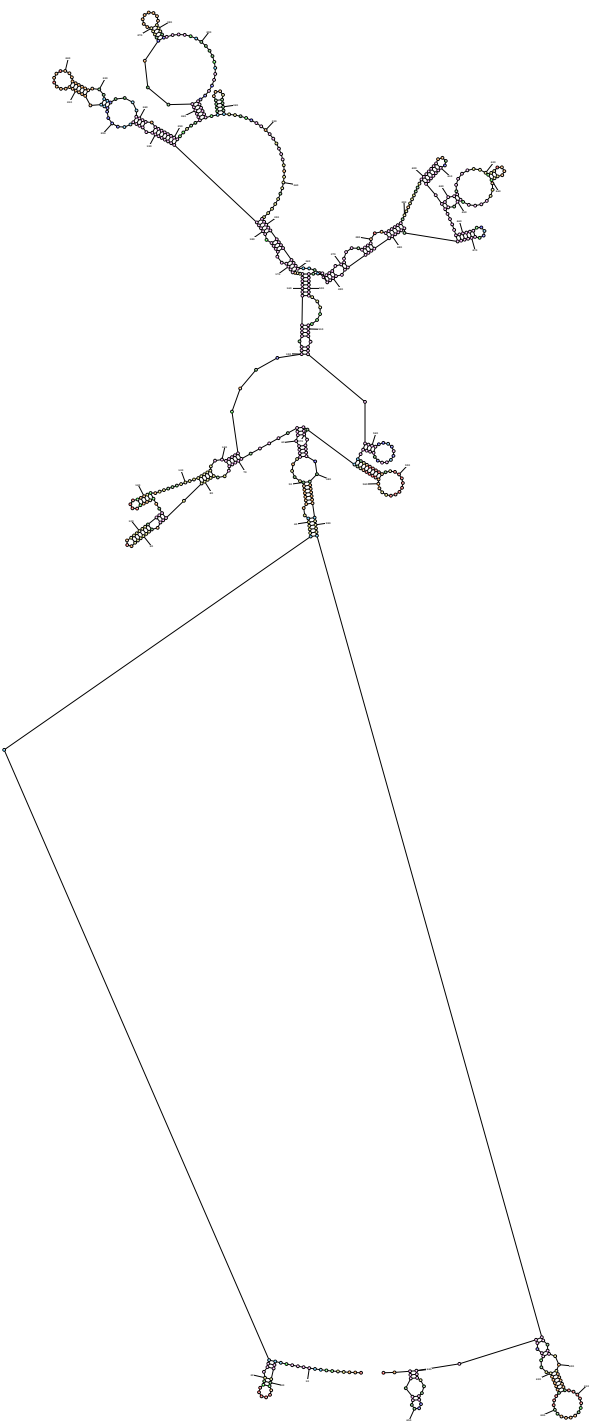

Probability >= 99%  
99% > Probability >= 95%  
95% > Probability >= 90%  
90% > Probability >= 80%  
80% > Probability >= 70%  
70% > Probability >= 60%  
60% > Probability >= 50%  
50% > Probability

ENERGY = -131.2 03/24/26 10:25:20

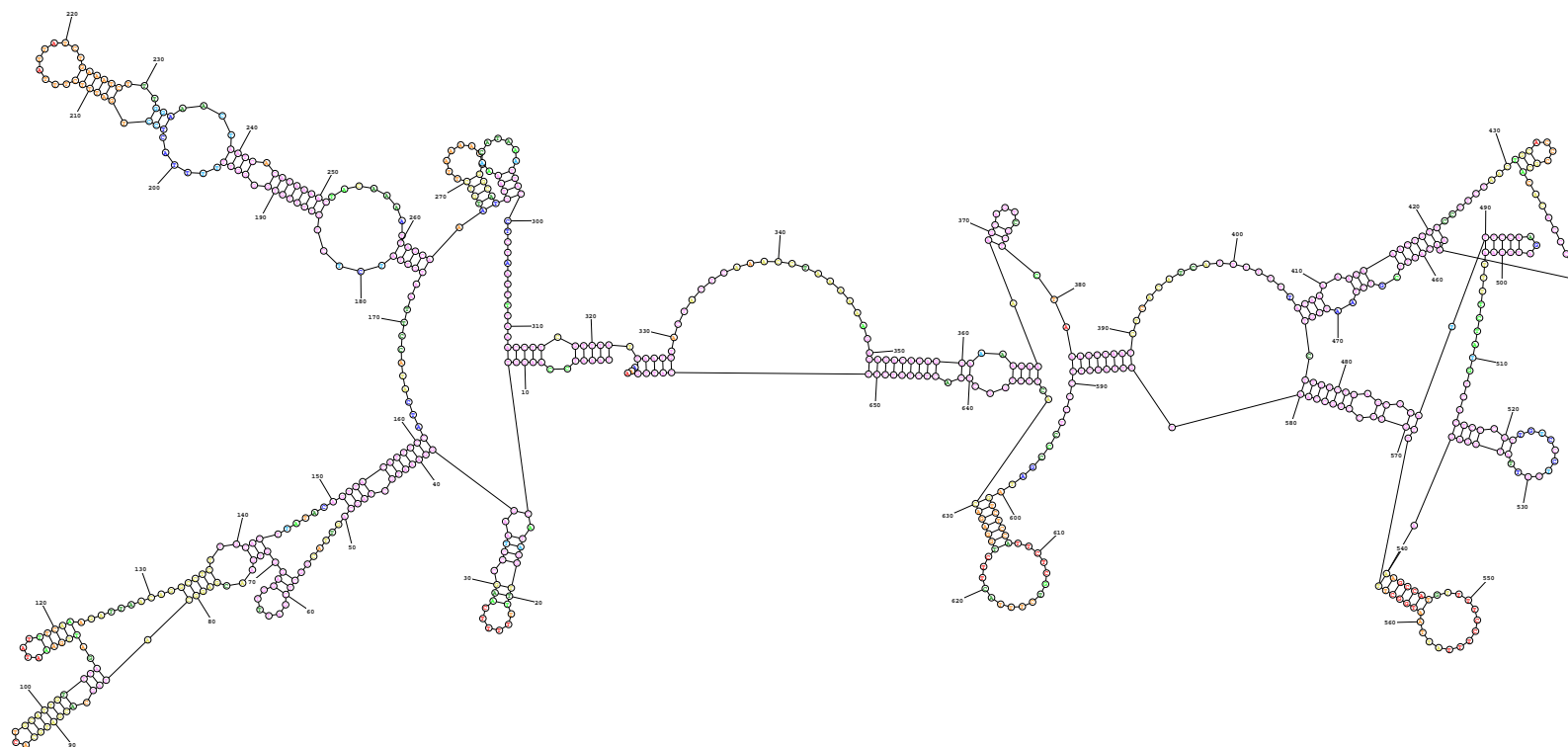

**Probability >= 99%**

**99% > Probability >= 95%**

**95% > Probability >= 90%**

**90% > Probability >= 80%**

**80% > Probability >= 70%**

**70% > Probability >= 60%**

**60% > Probability >= 50%**

**50% > Probability**

**ENERGY = -131.2 03/24/26 10:25:20**

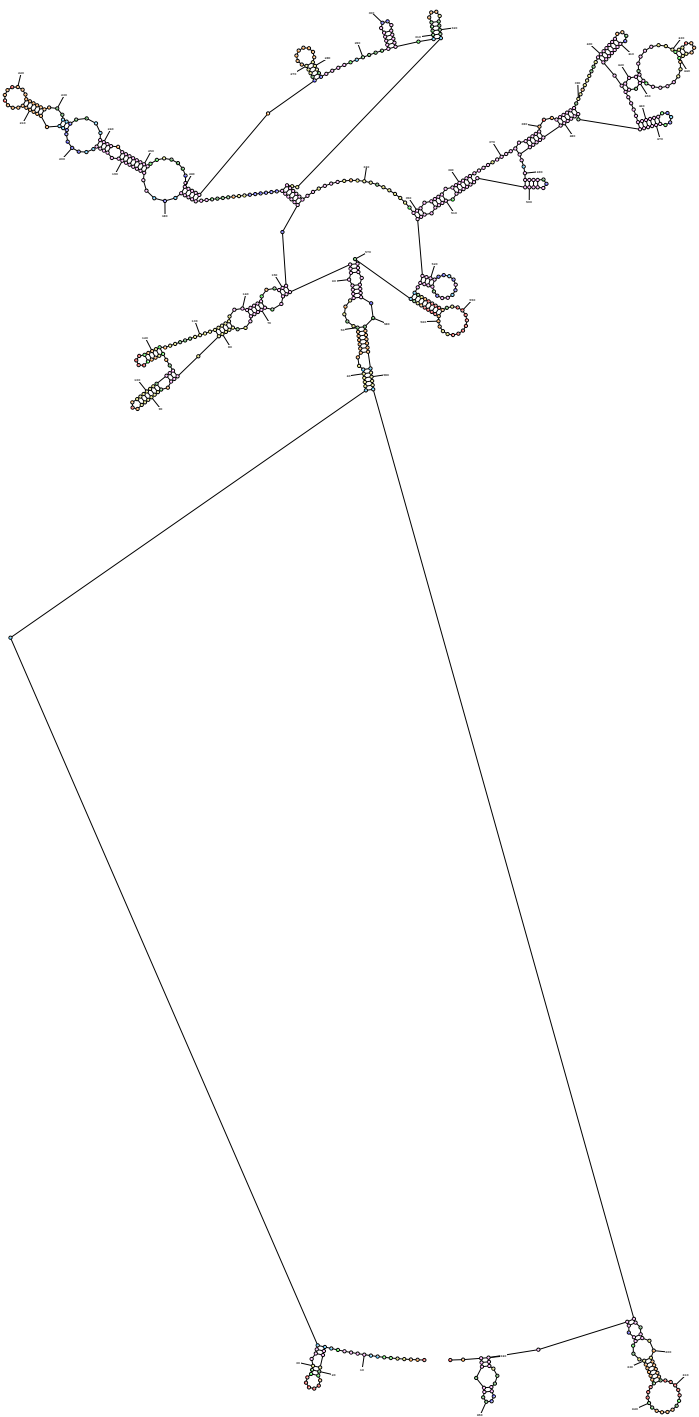

**Probability >= 99%**  
**99% > Probability >= 95%**  
**95% > Probability >= 90%**  
**90% > Probability >= 80%**  
**80% > Probability >= 70%**  
**70% > Probability >= 60%**  
**60% > Probability >= 50%**  
**50% > Probability**

**ENERGY = -131.1 03/24/26 10:25:20**

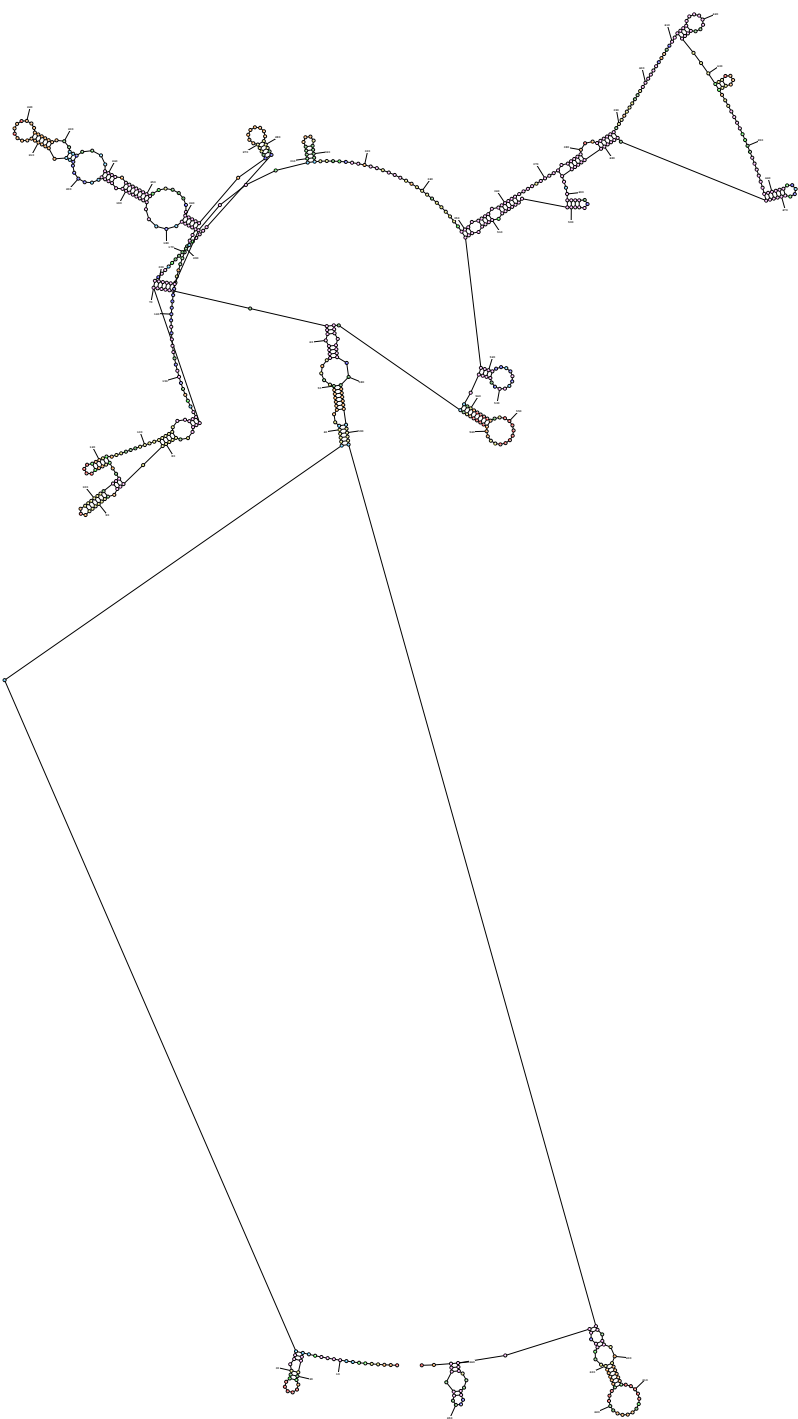

**Probability >= 99%**  
**99% > Probability >= 95%**  
**95% > Probability >= 90%**  
**90% > Probability >= 80%**  
**80% > Probability >= 70%**  
**70% > Probability >= 60%**  
**60% > Probability >= 50%**  
**50% > Probability**

**ENERGY = -131.1 03/24/26 10:25:20**

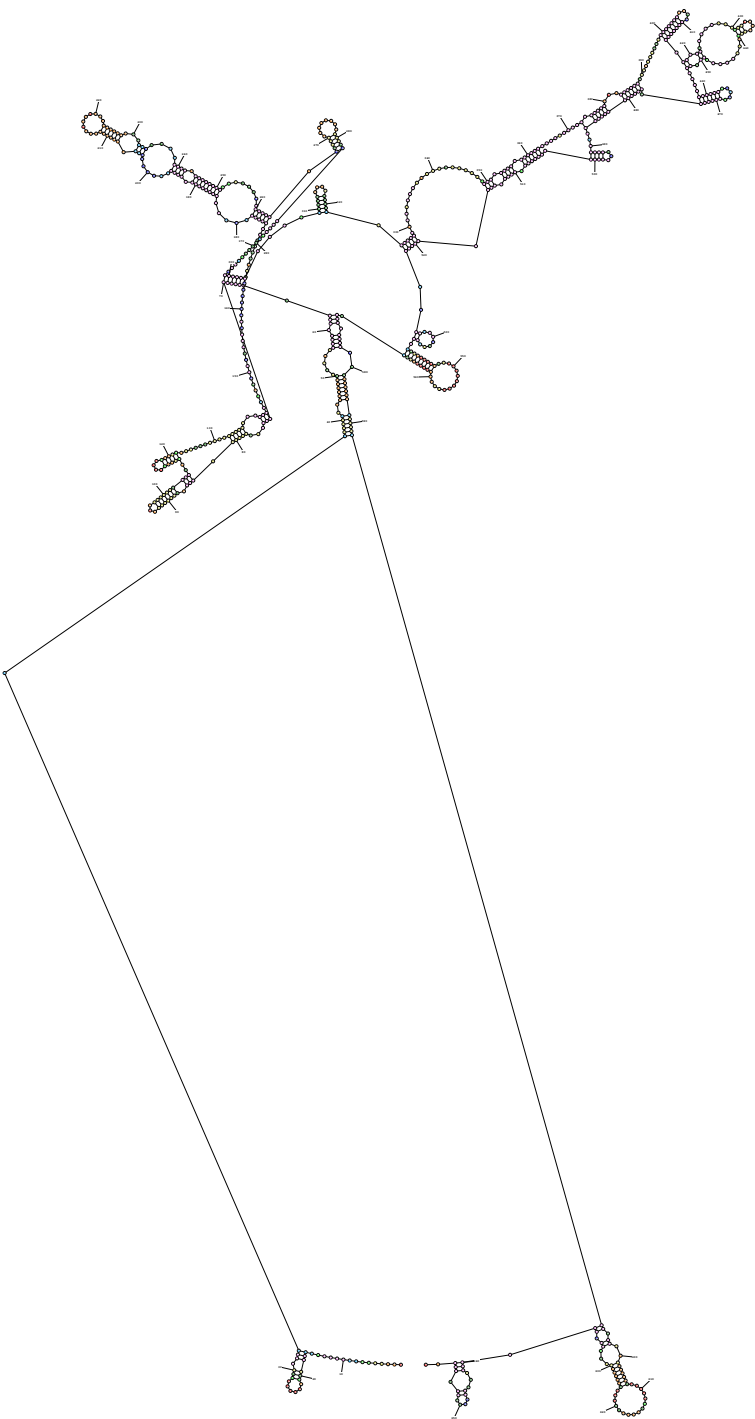

**Probability >= 99%**  
**99% > Probability >= 95%**  
**95% > Probability >= 90%**  
**90% > Probability >= 80%**  
**80% > Probability >= 70%**  
**70% > Probability >= 60%**  
**60% > Probability >= 50%**  
**50% > Probability**

**ENERGY = -131.1 03/24/26 10:25:20**