

ENERGY = -51.0 04/23/26 18:02:37

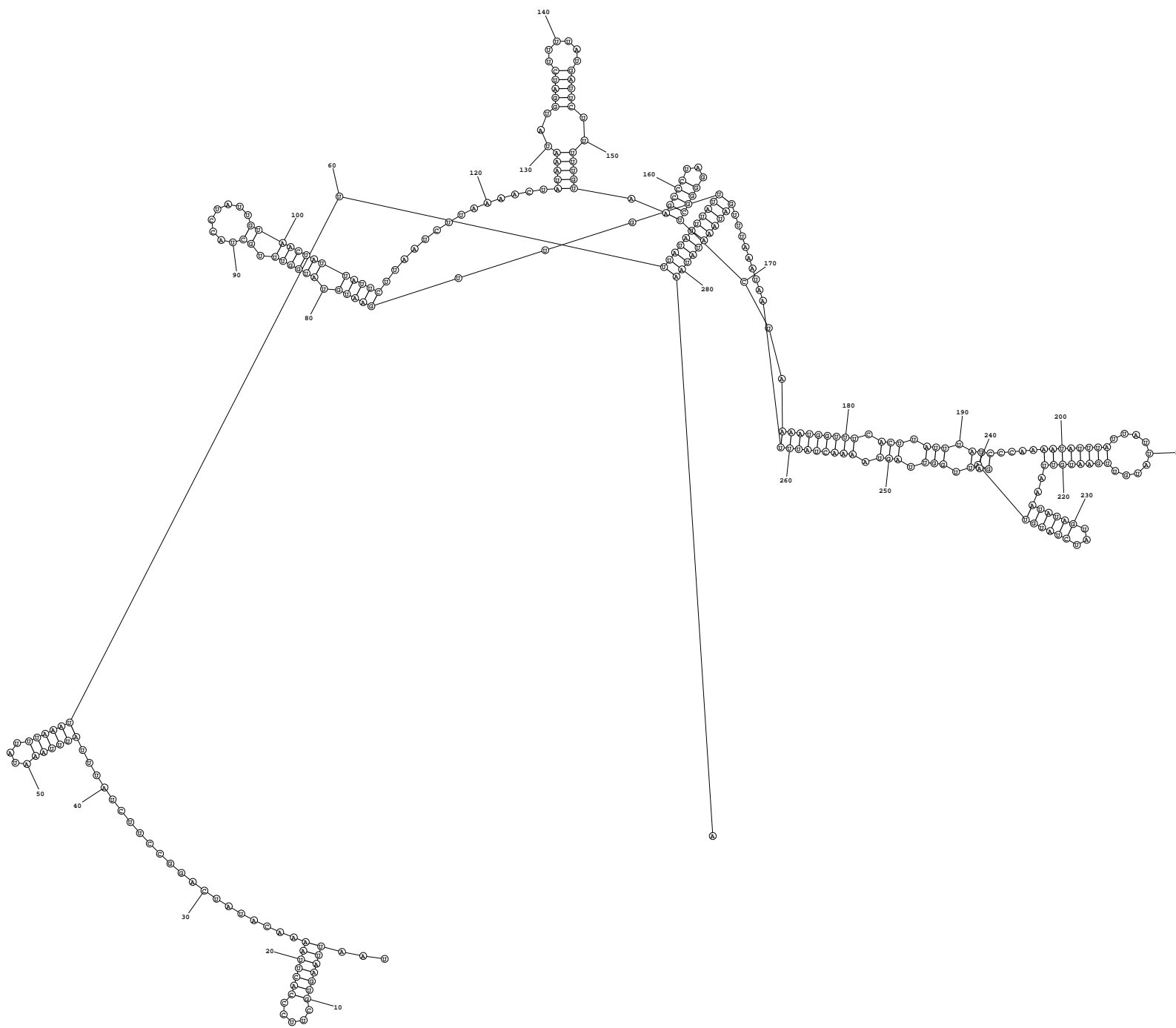

ENERGY = -48.7 04/23/26 18:02:37

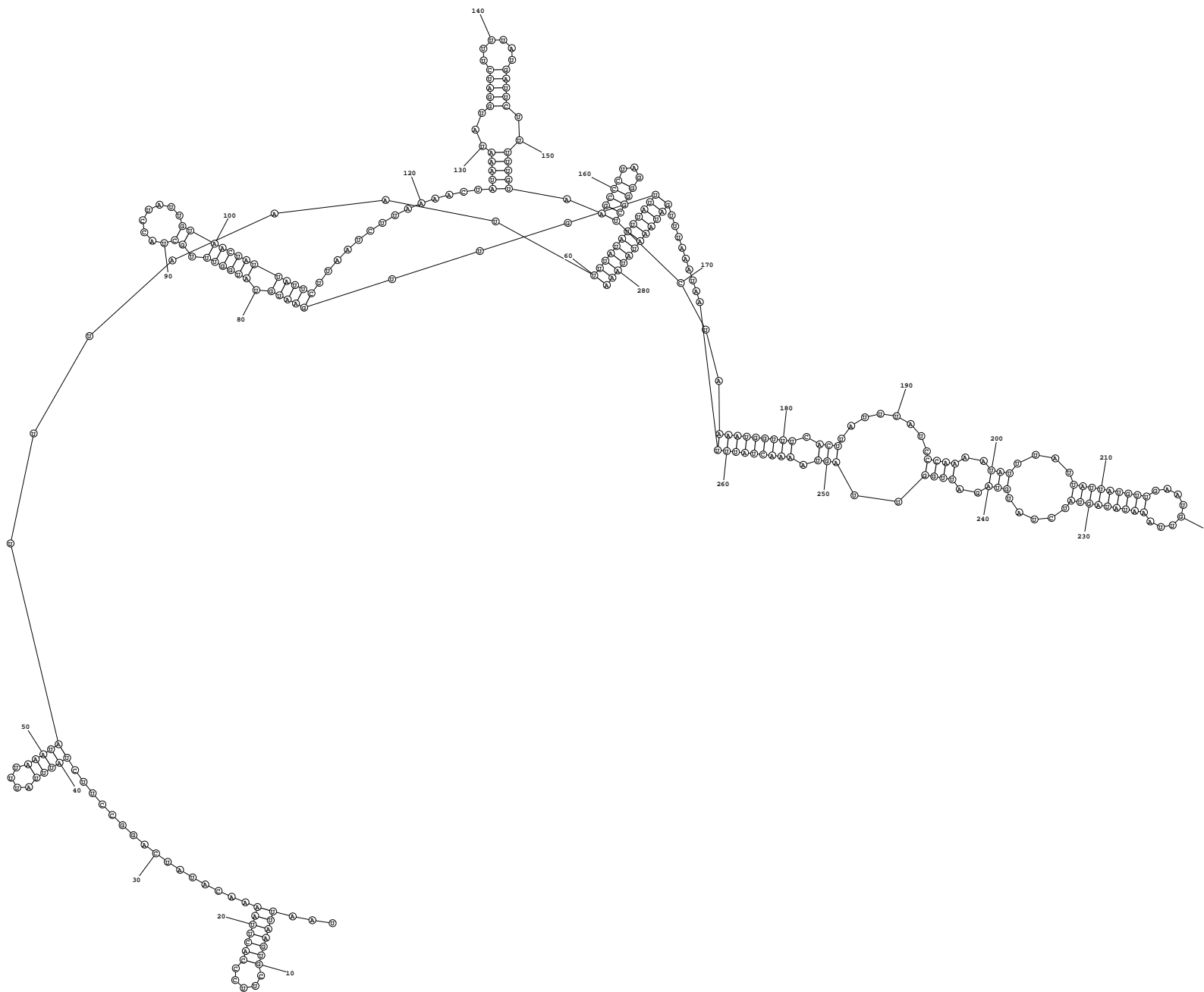

ENERGY = -48.3 04/23/26 18:02:37

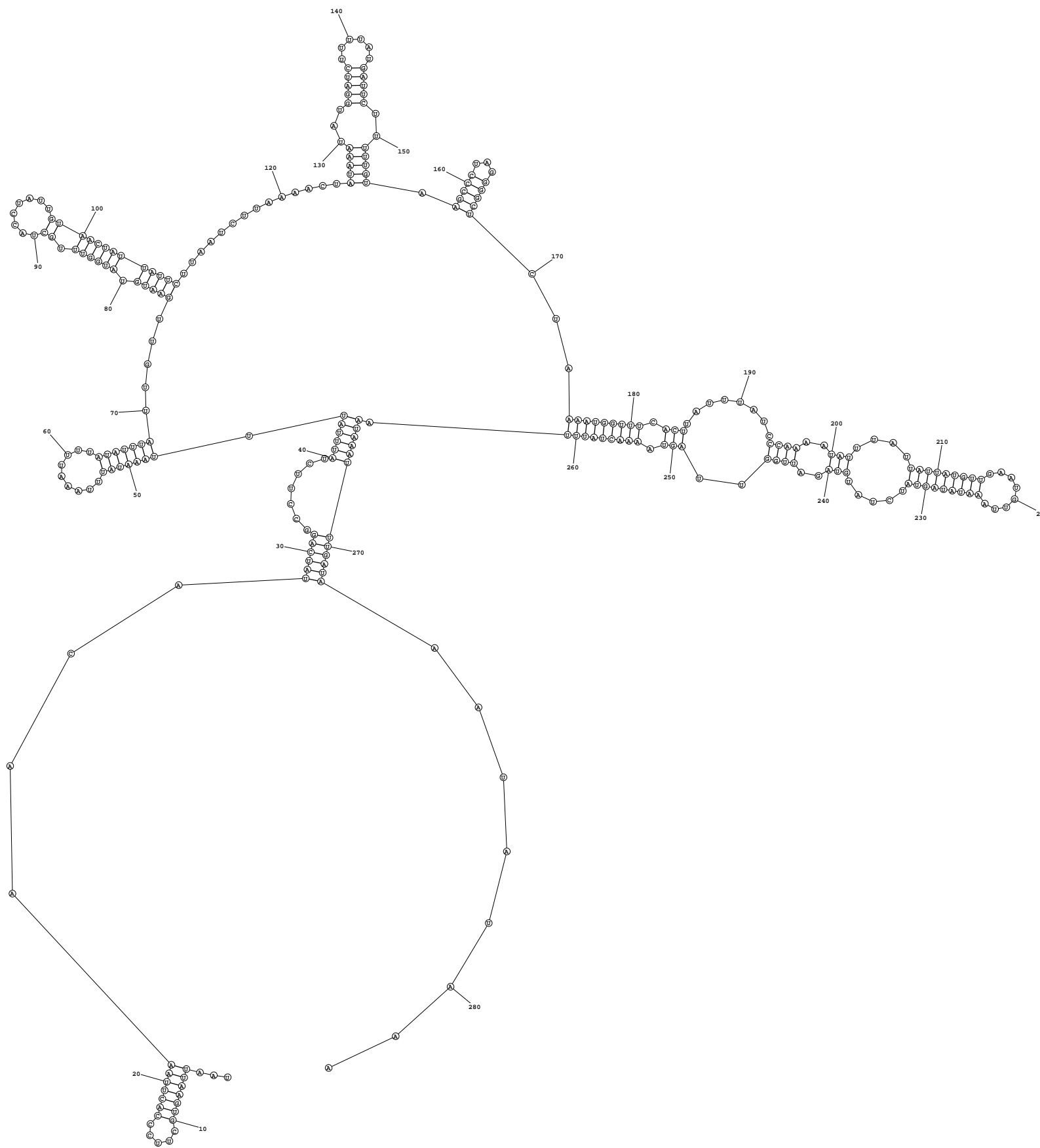

ENERGY = -48.2 04/23/26 18:02:37

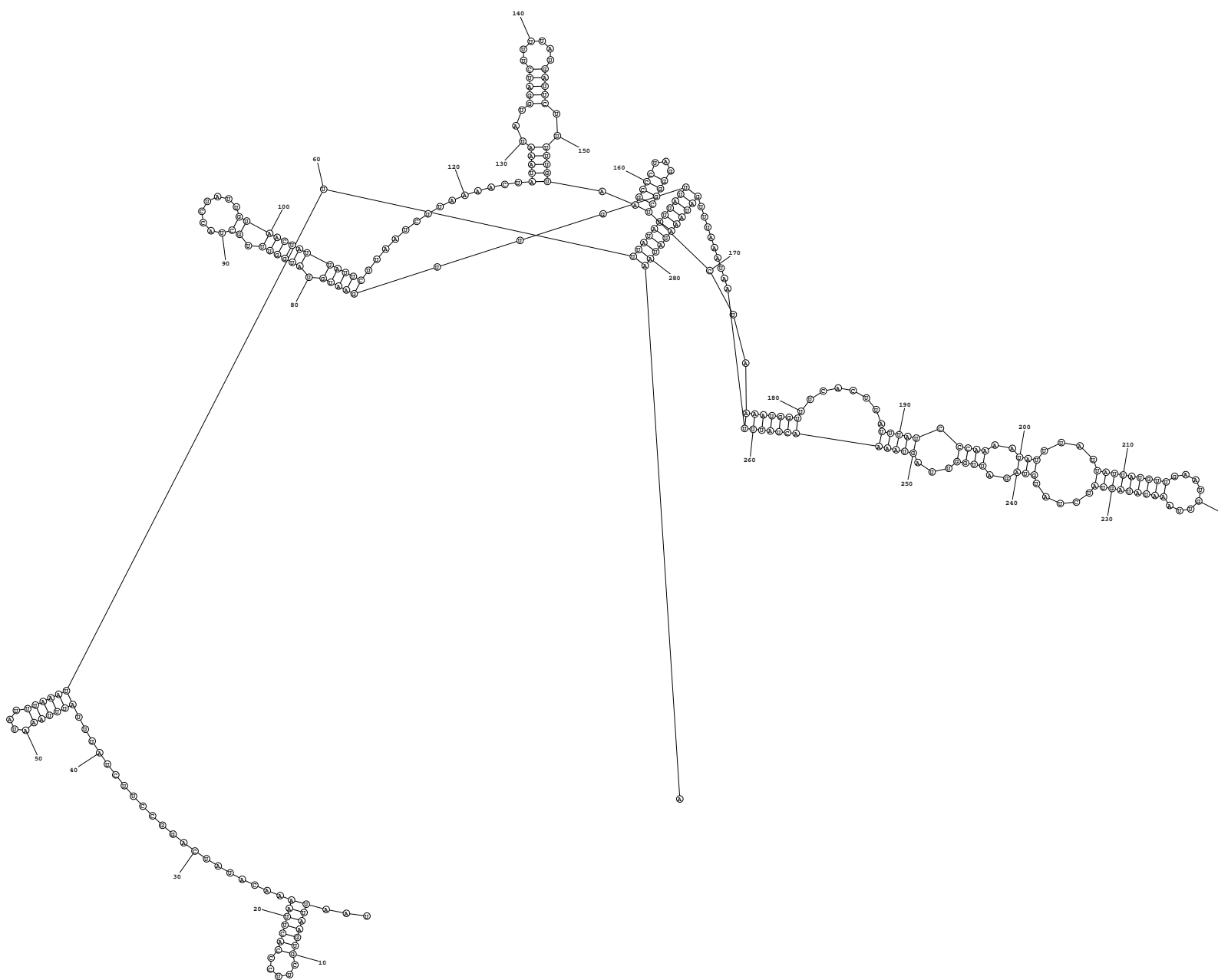

ENERGY = -48.2 04/23/26 18:02:37

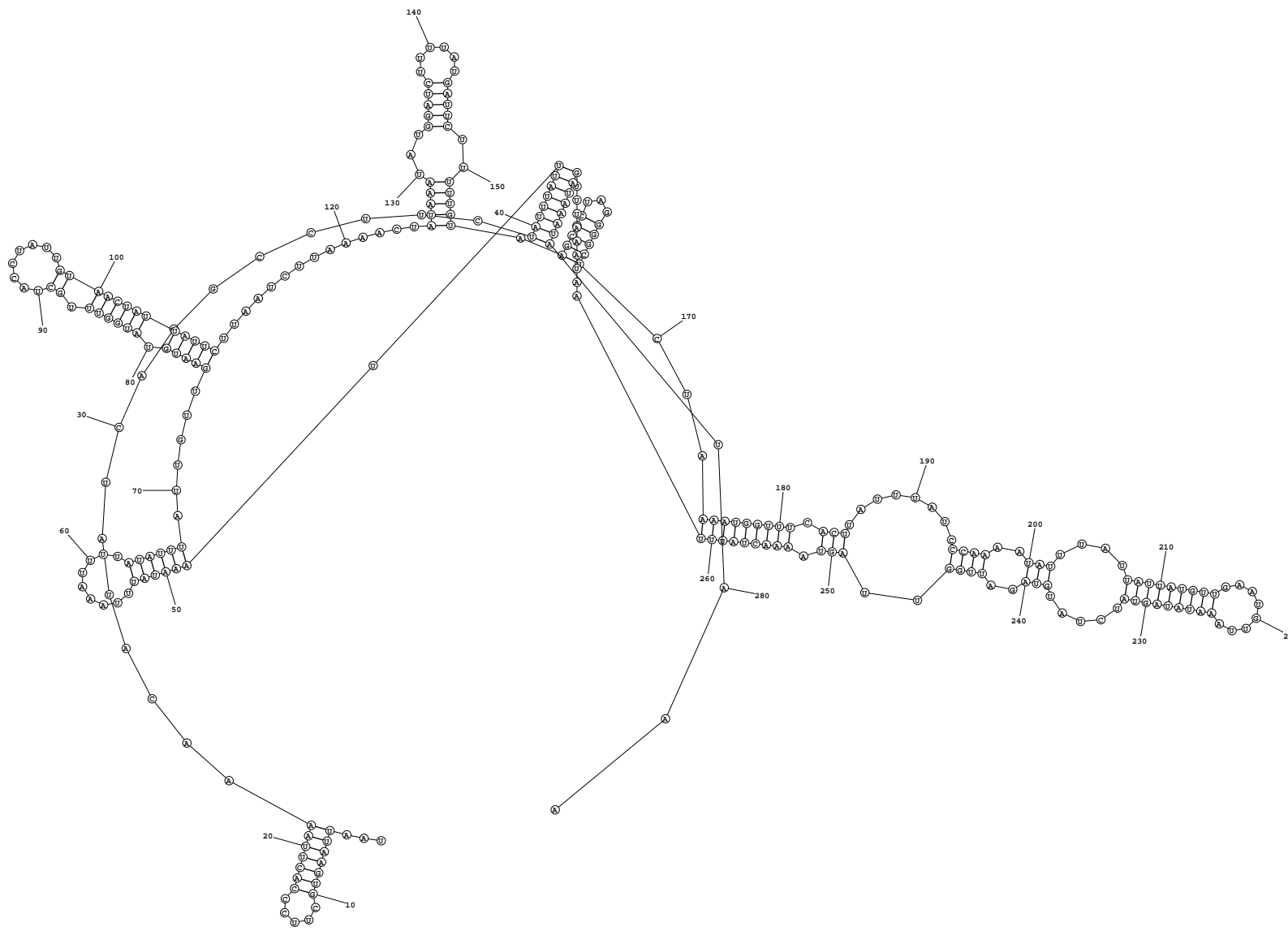

ENERGY = -47.9 04/23/26 18:02:37

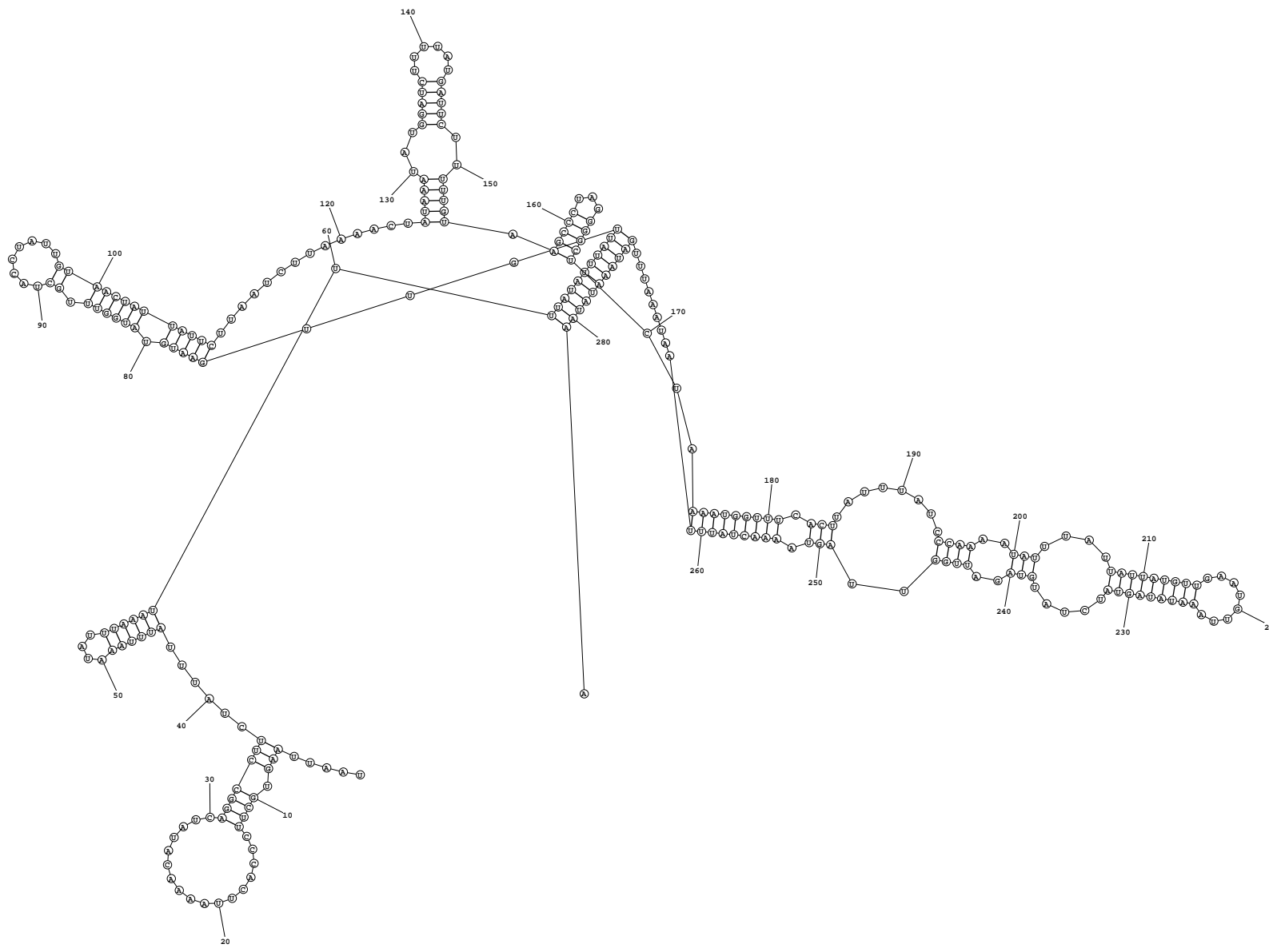

ENERGY = -47.8 04/23/26 18:02:37

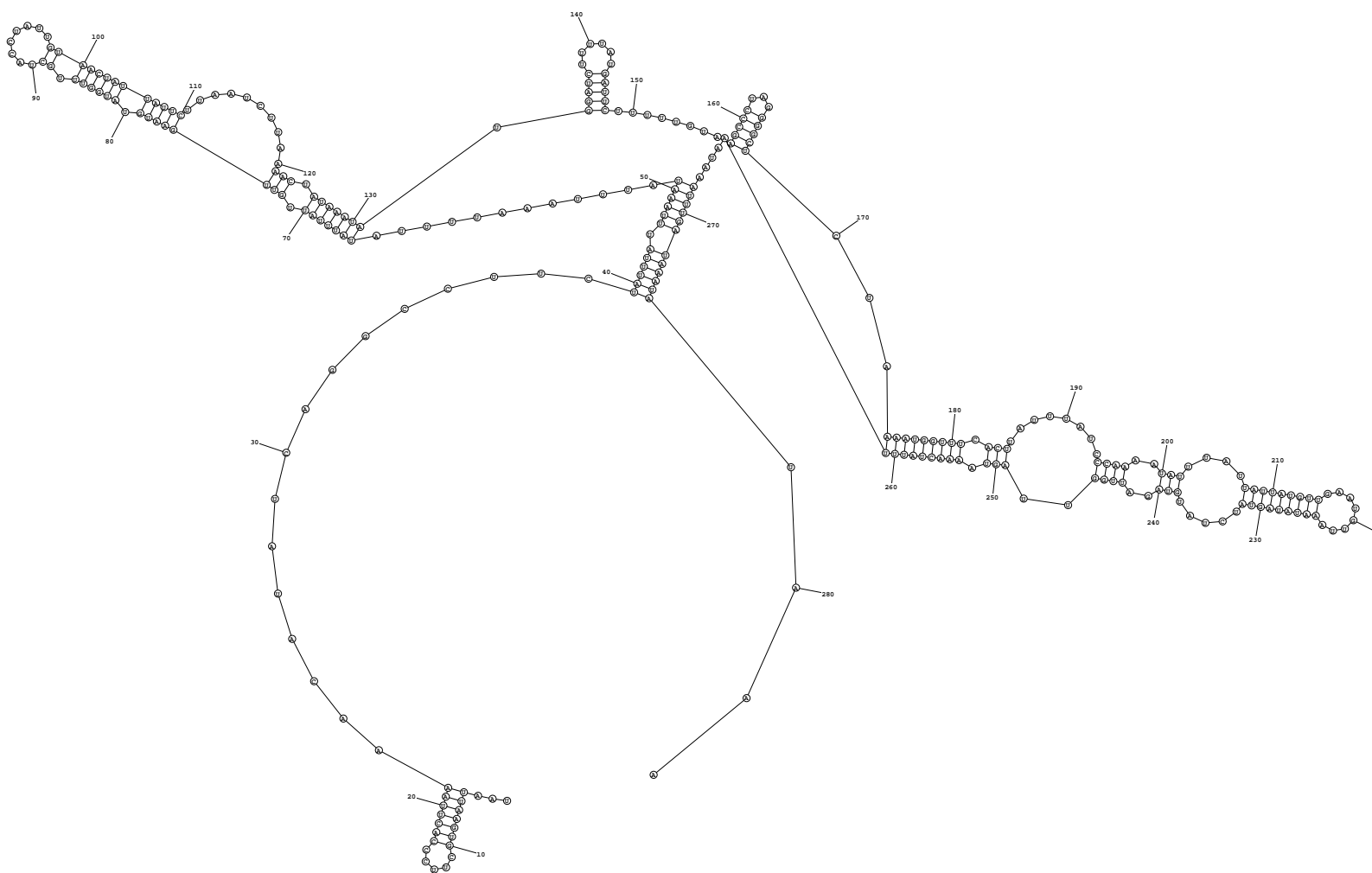

ENERGY = -47.7 04/23/26 18:02:37

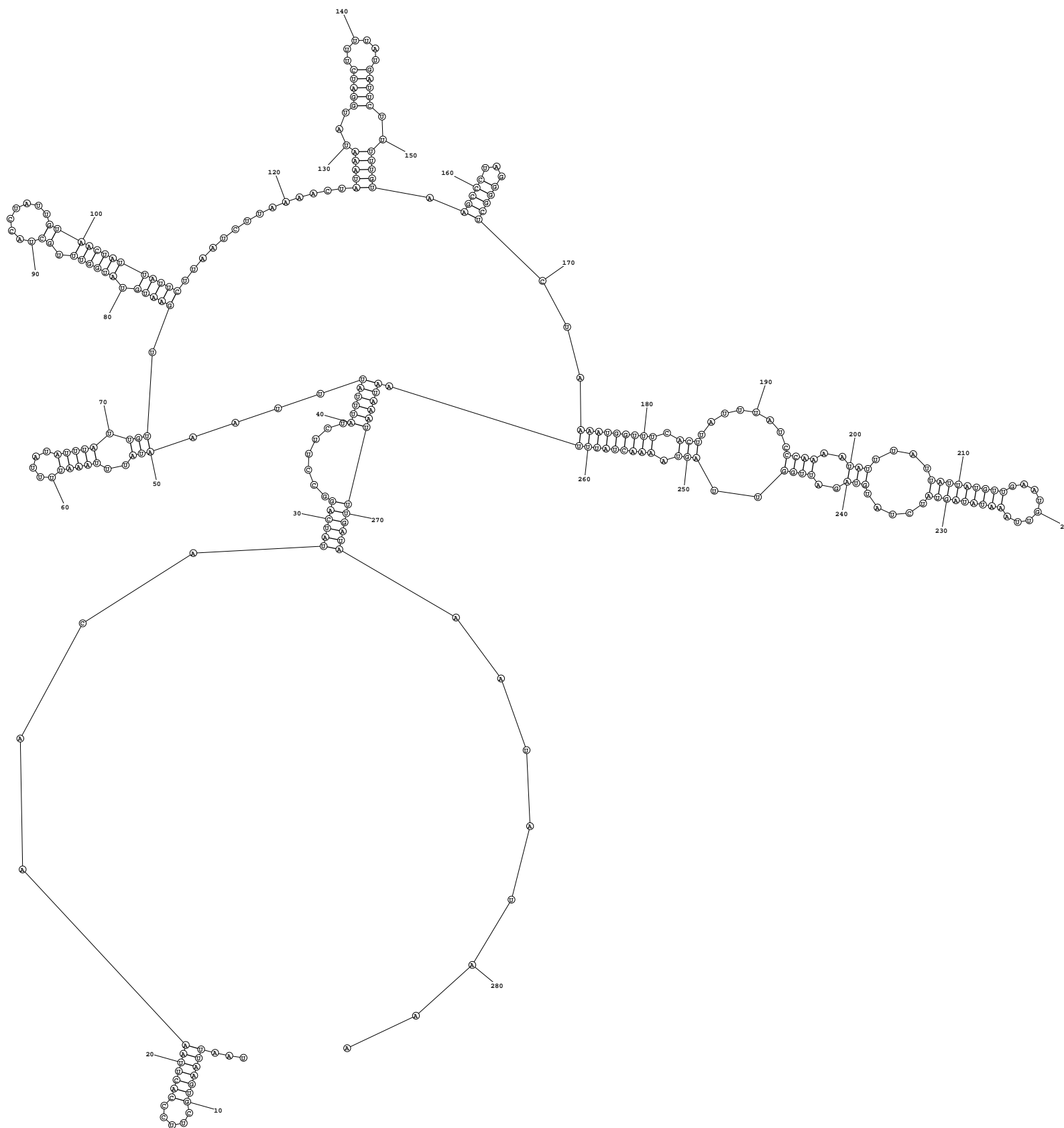

ENERGY = -47.3 04/23/26 18:02:37

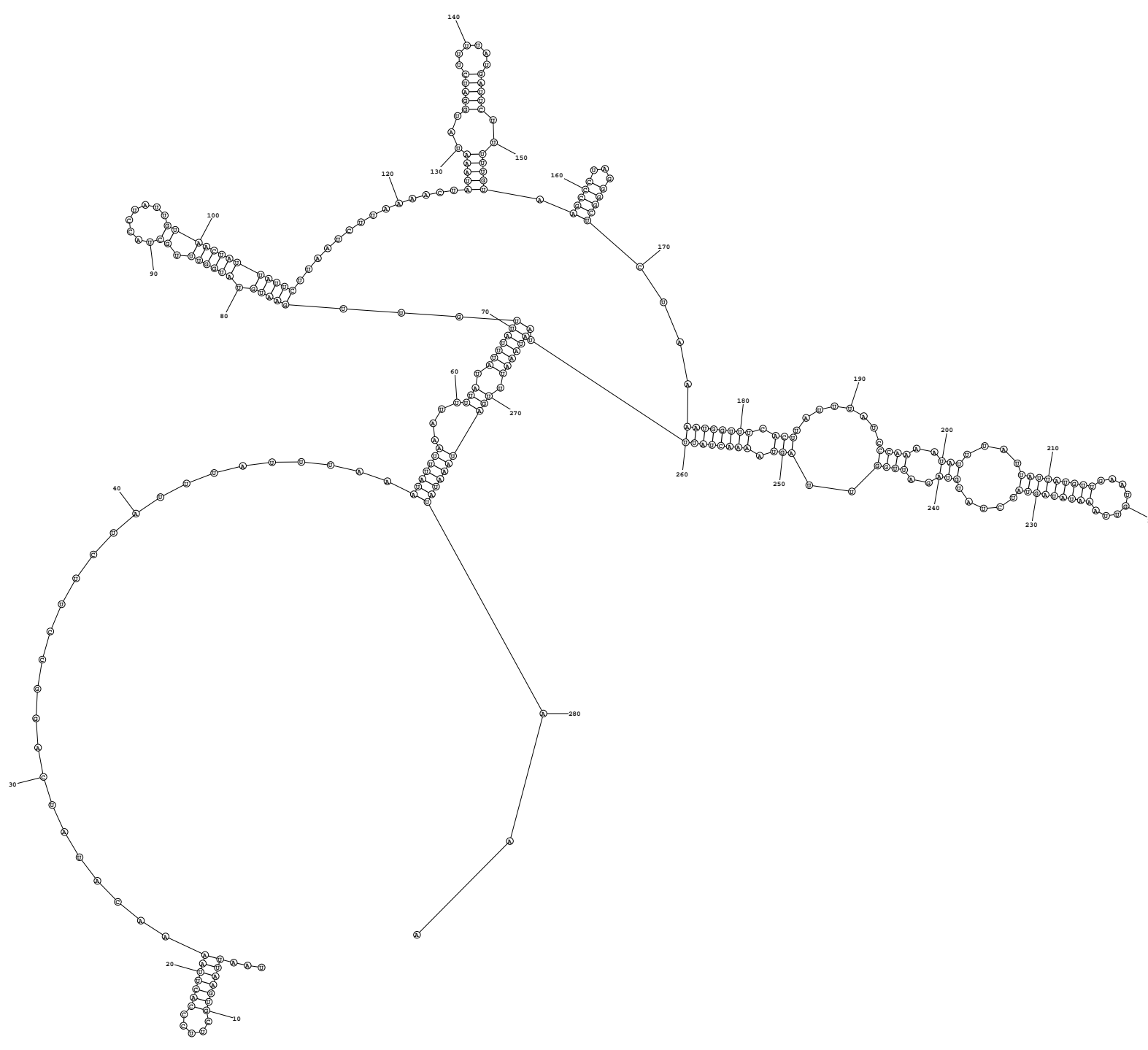

ENERGY = -47.3 04/23/26 18:02:37

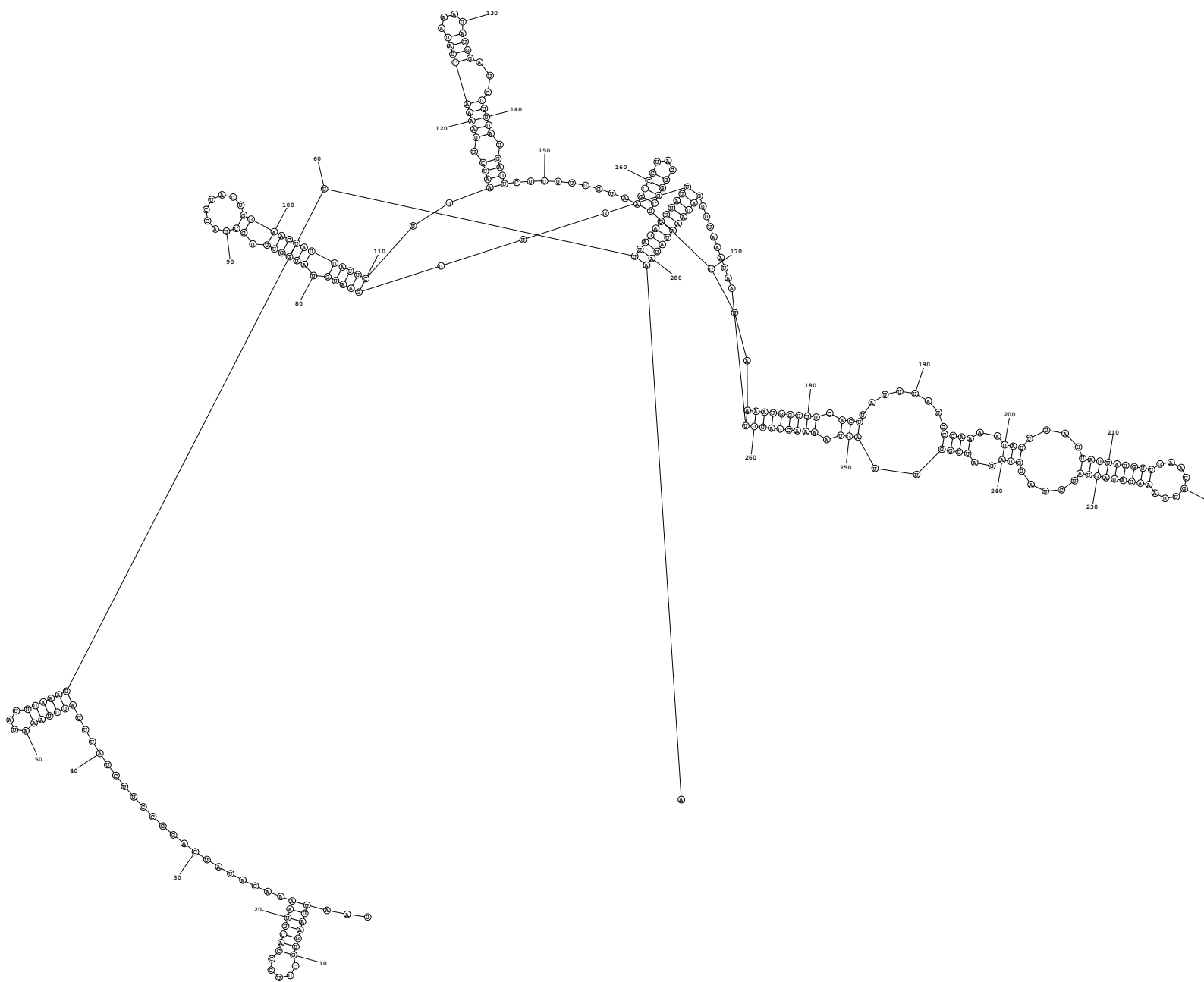

ENERGY = -47.2 04/23/26 18:02:37

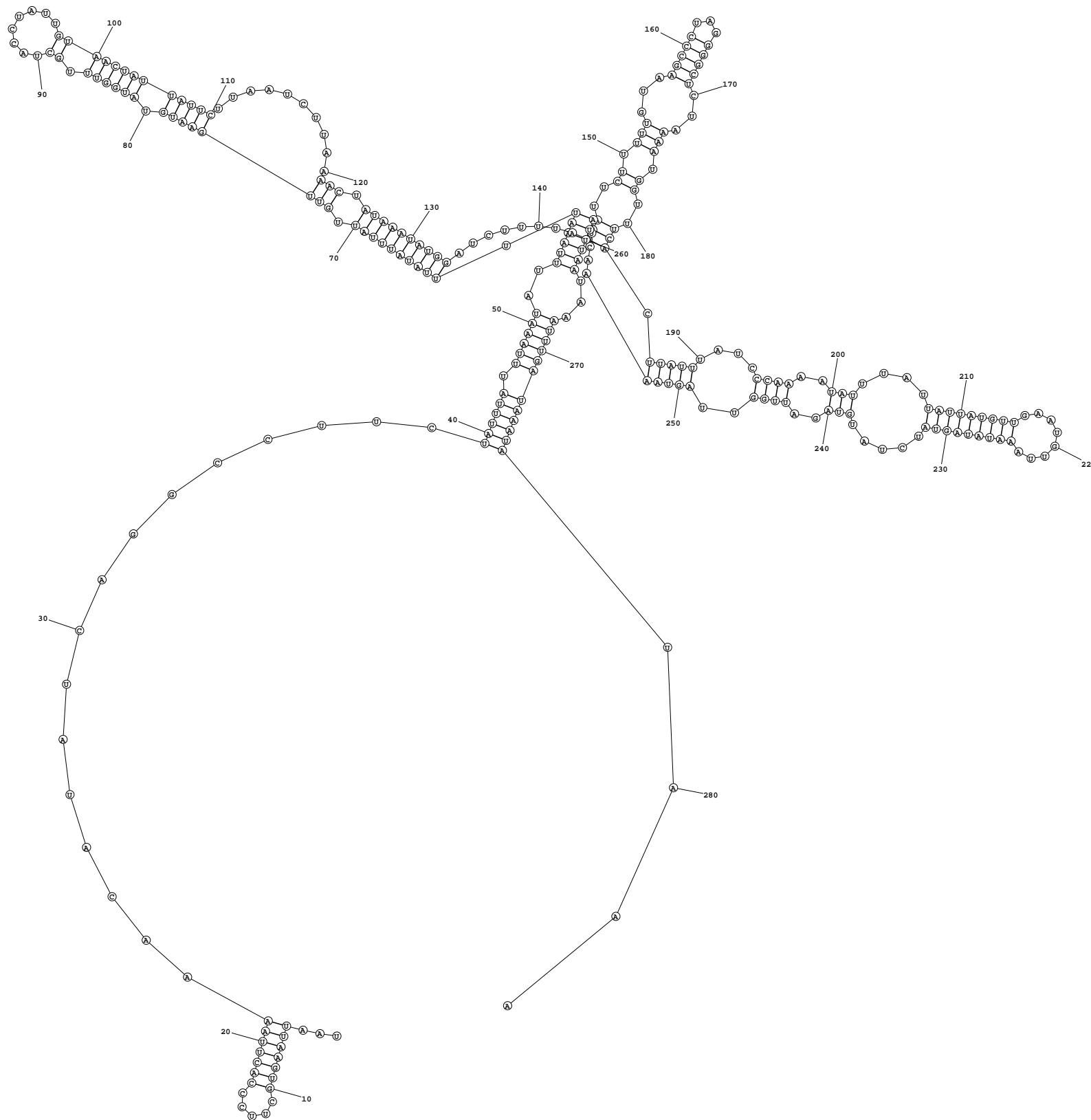

ENERGY = -47.2 04/23/26 18:02:37

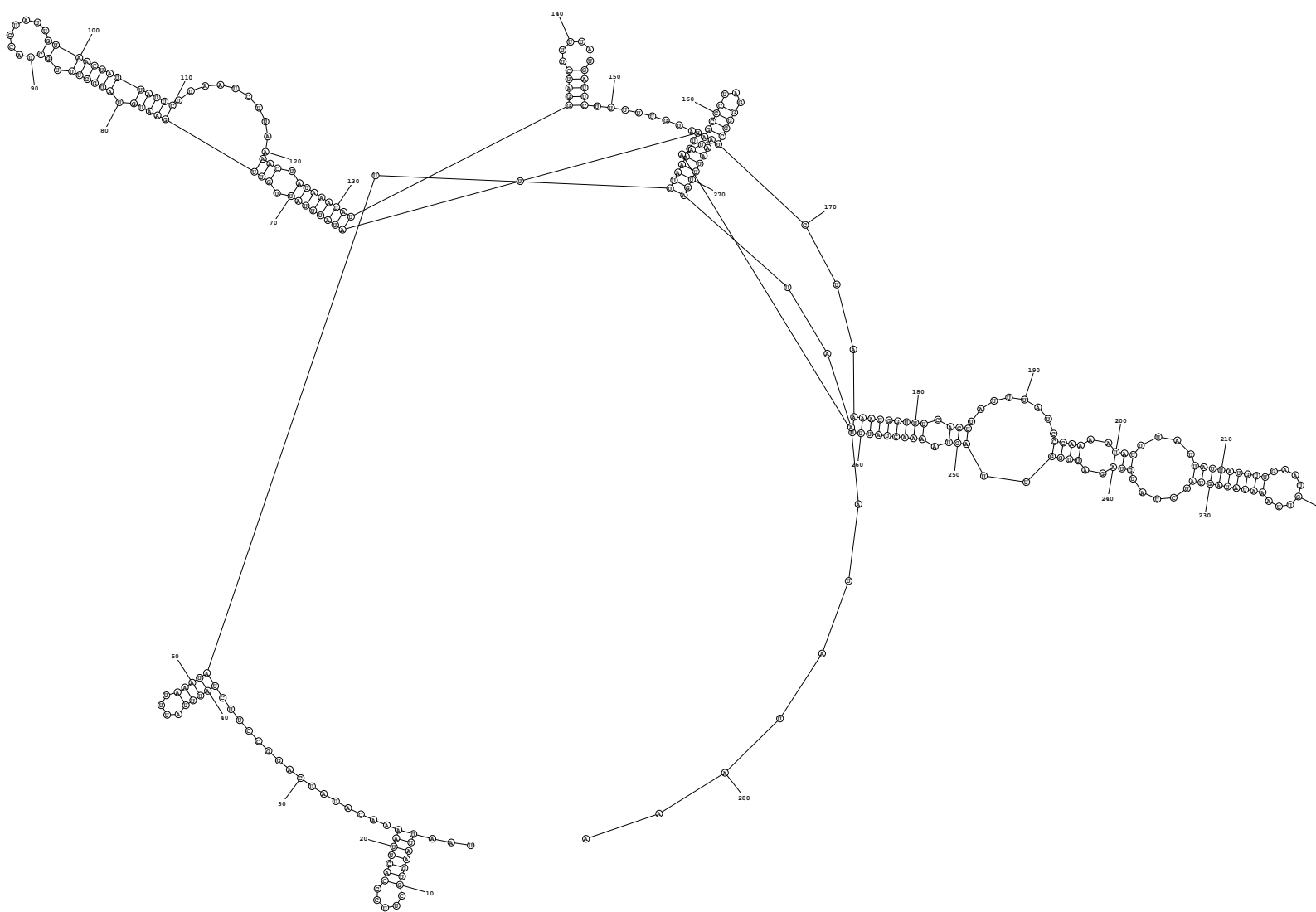

ENERGY = -47.2 04/23/26 18:02:37

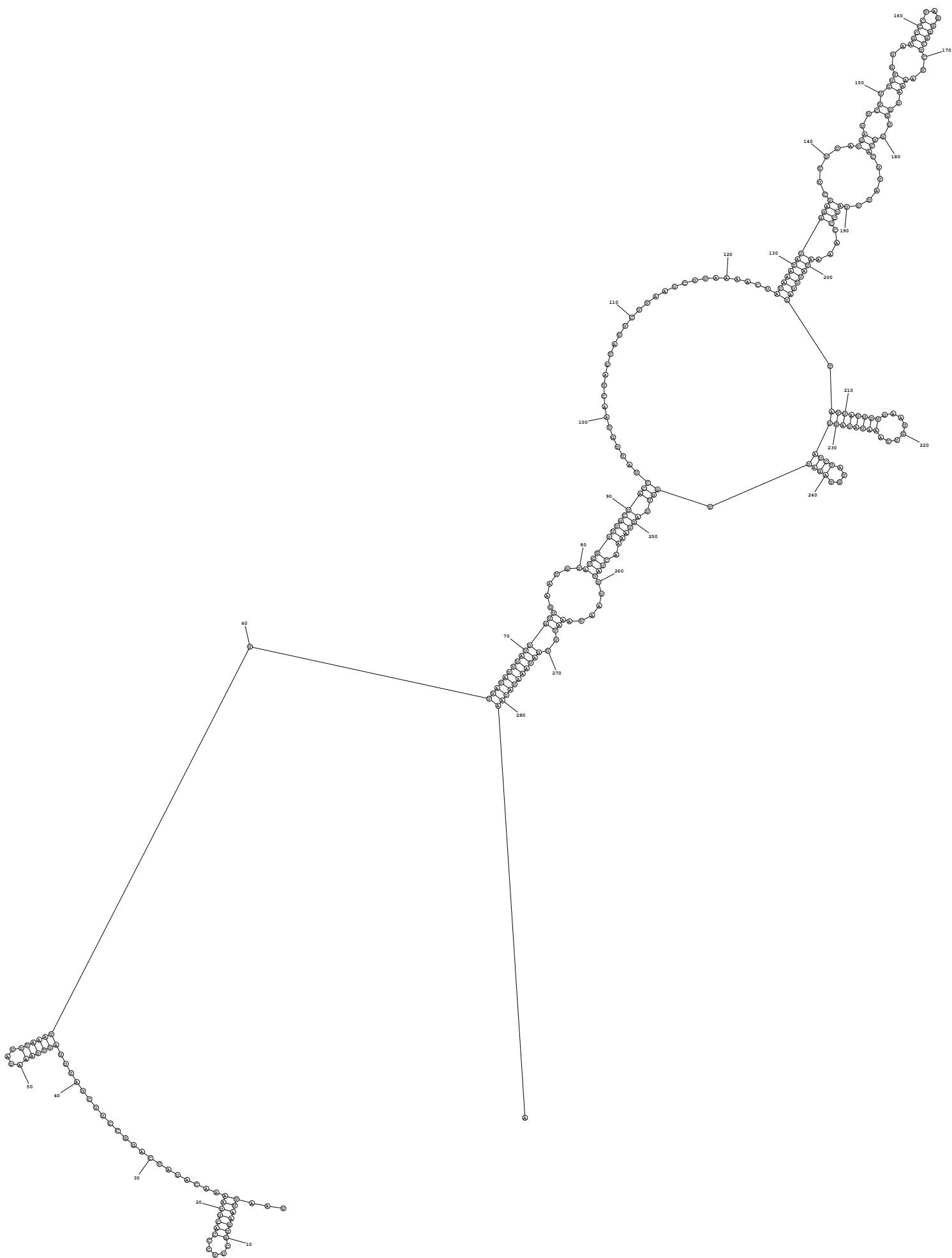

ENERGY = -47.2 04/23/26 18:02:37

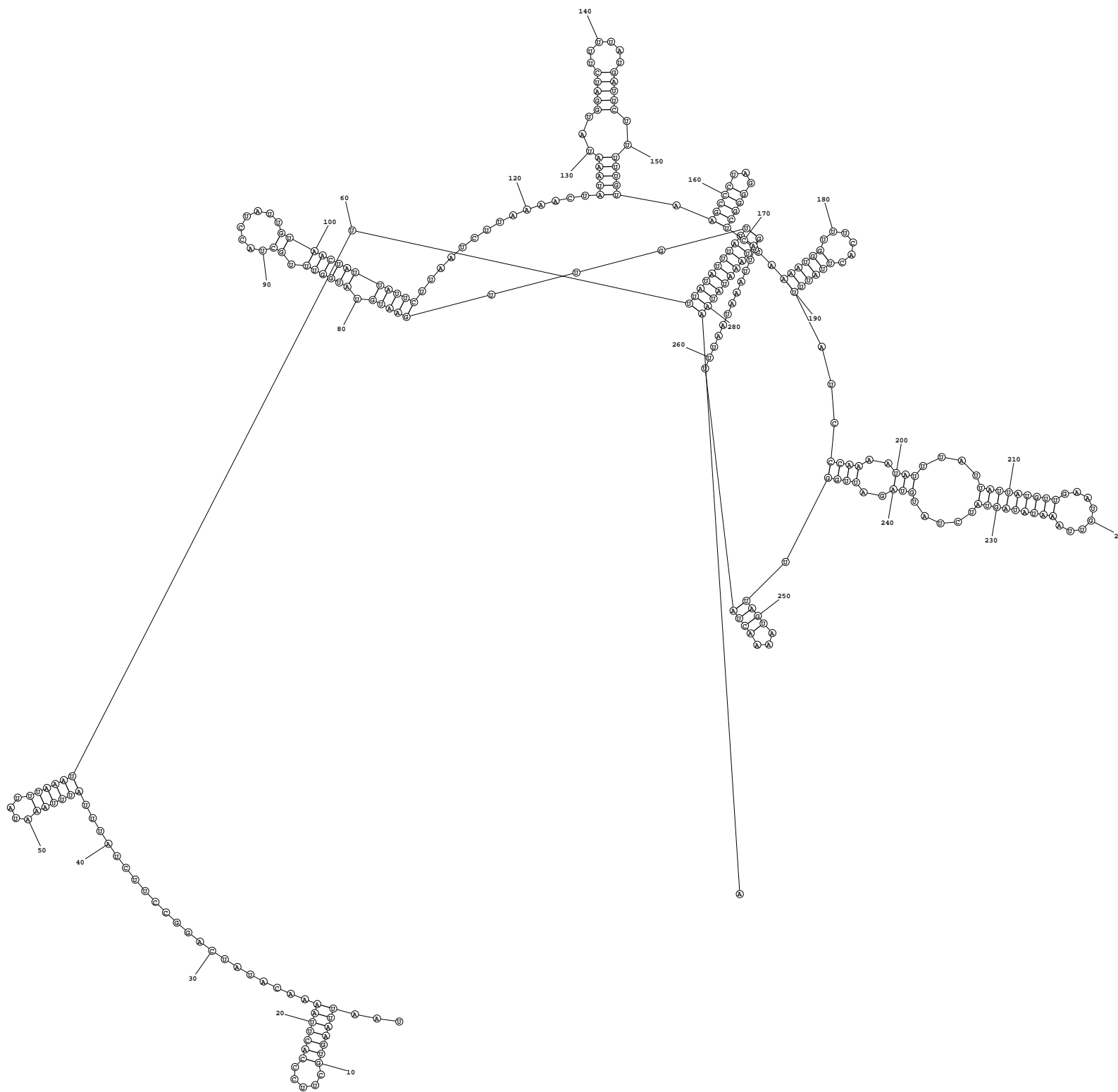

ENERGY = -47.1 04/23/26 18:02:37

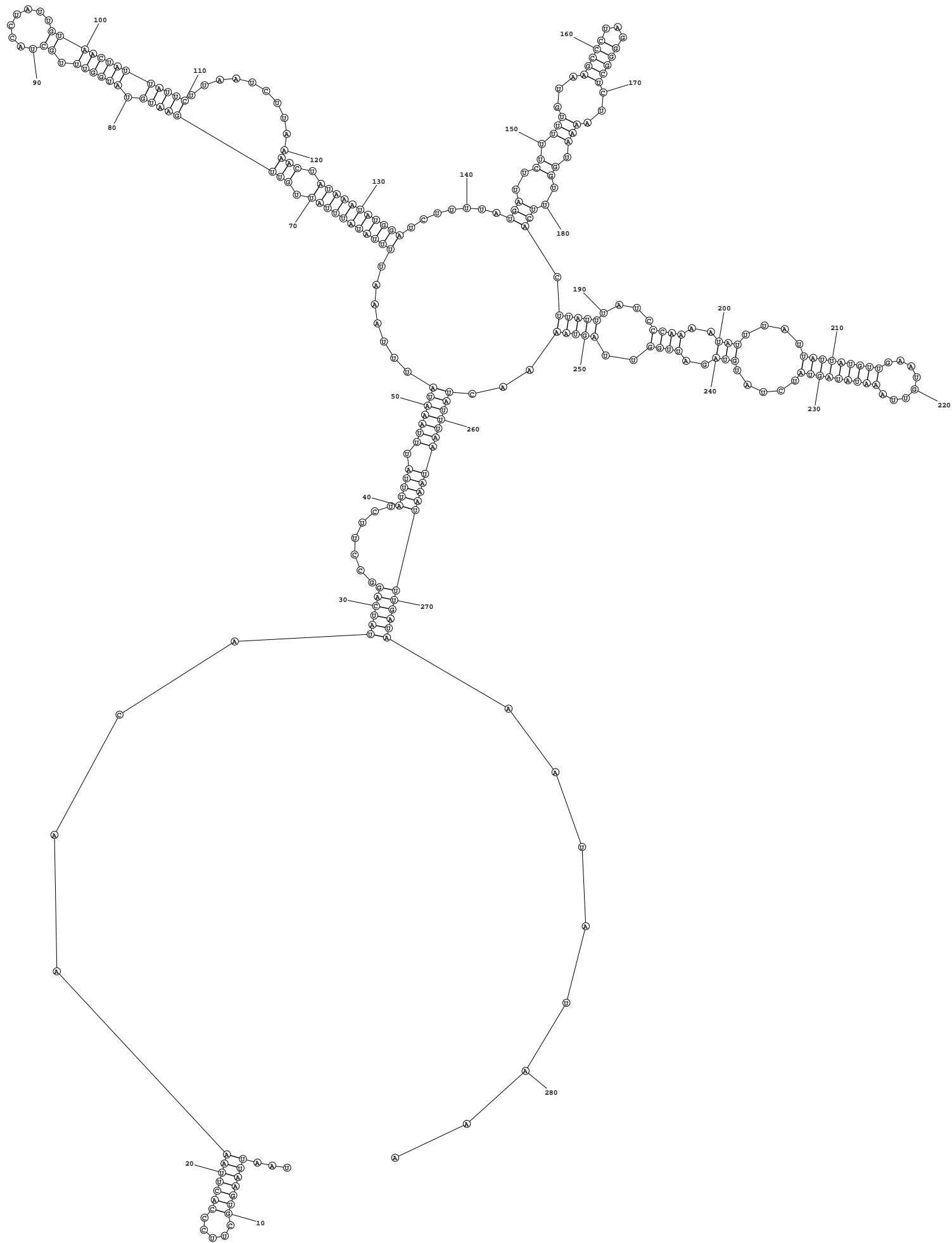

ENERGY = -47.0 04/23/26 18:02:37

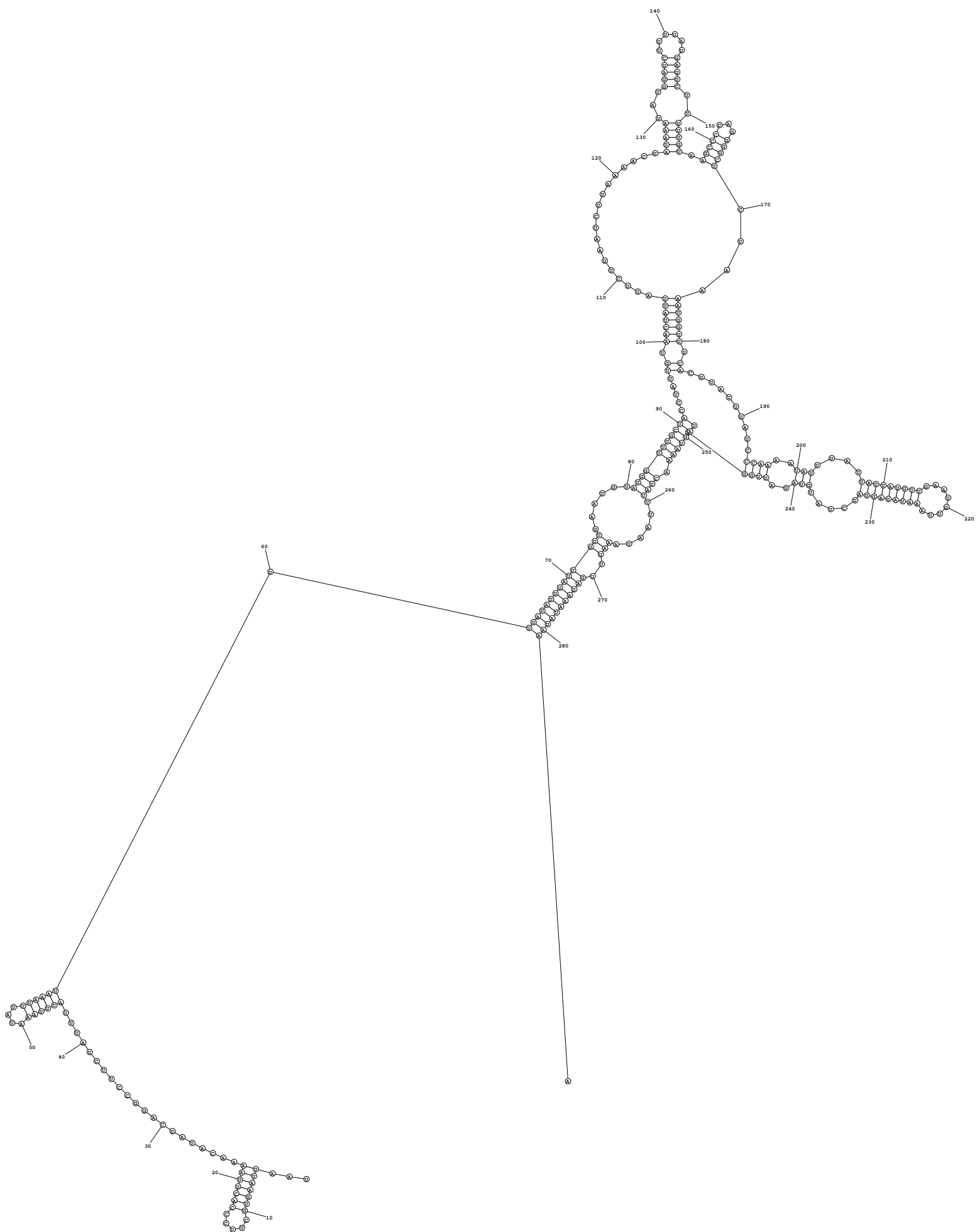

ENERGY = -47.0 04/23/26 18:02:37

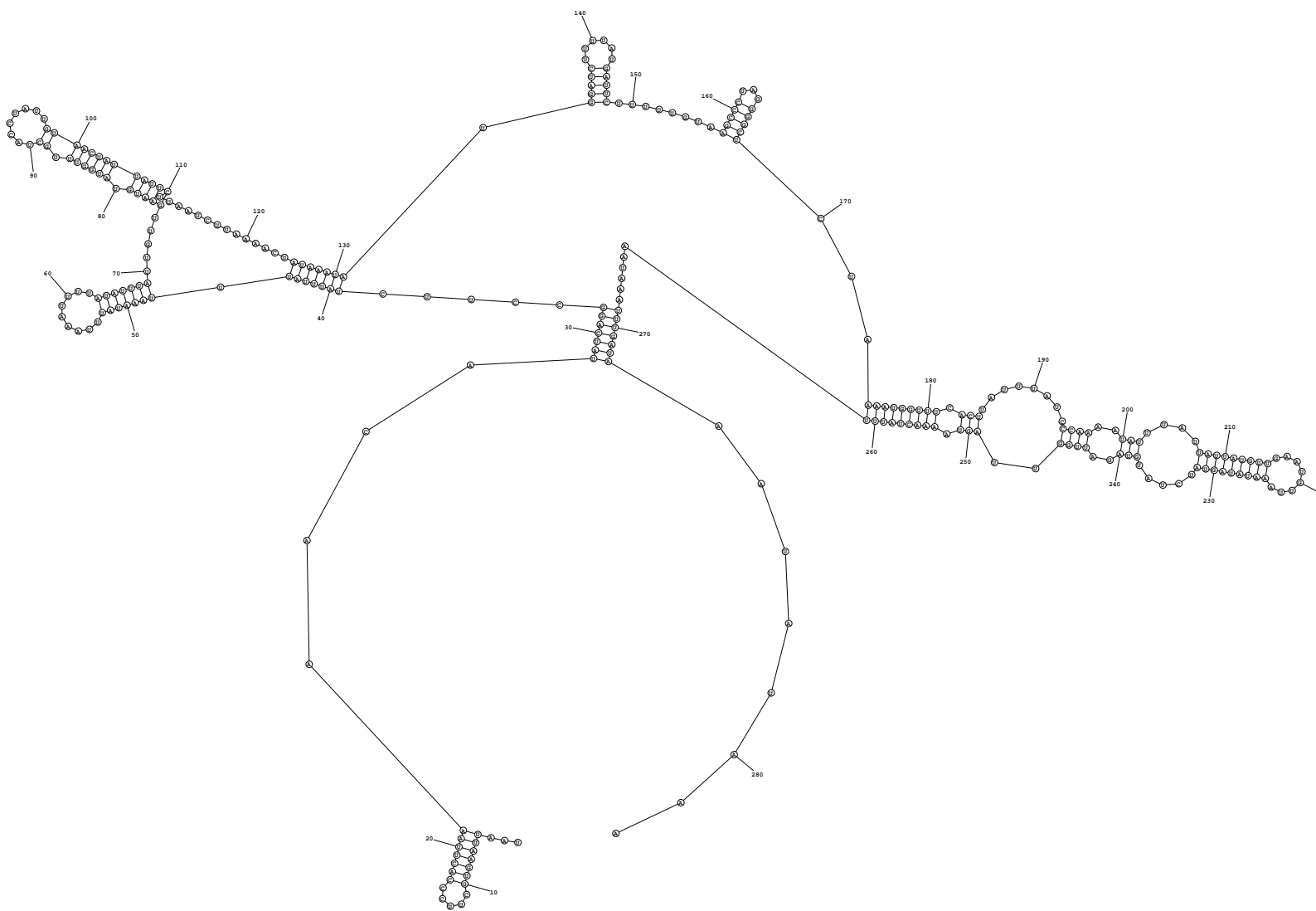

ENERGY = -46.9 04/23/26 18:02:37

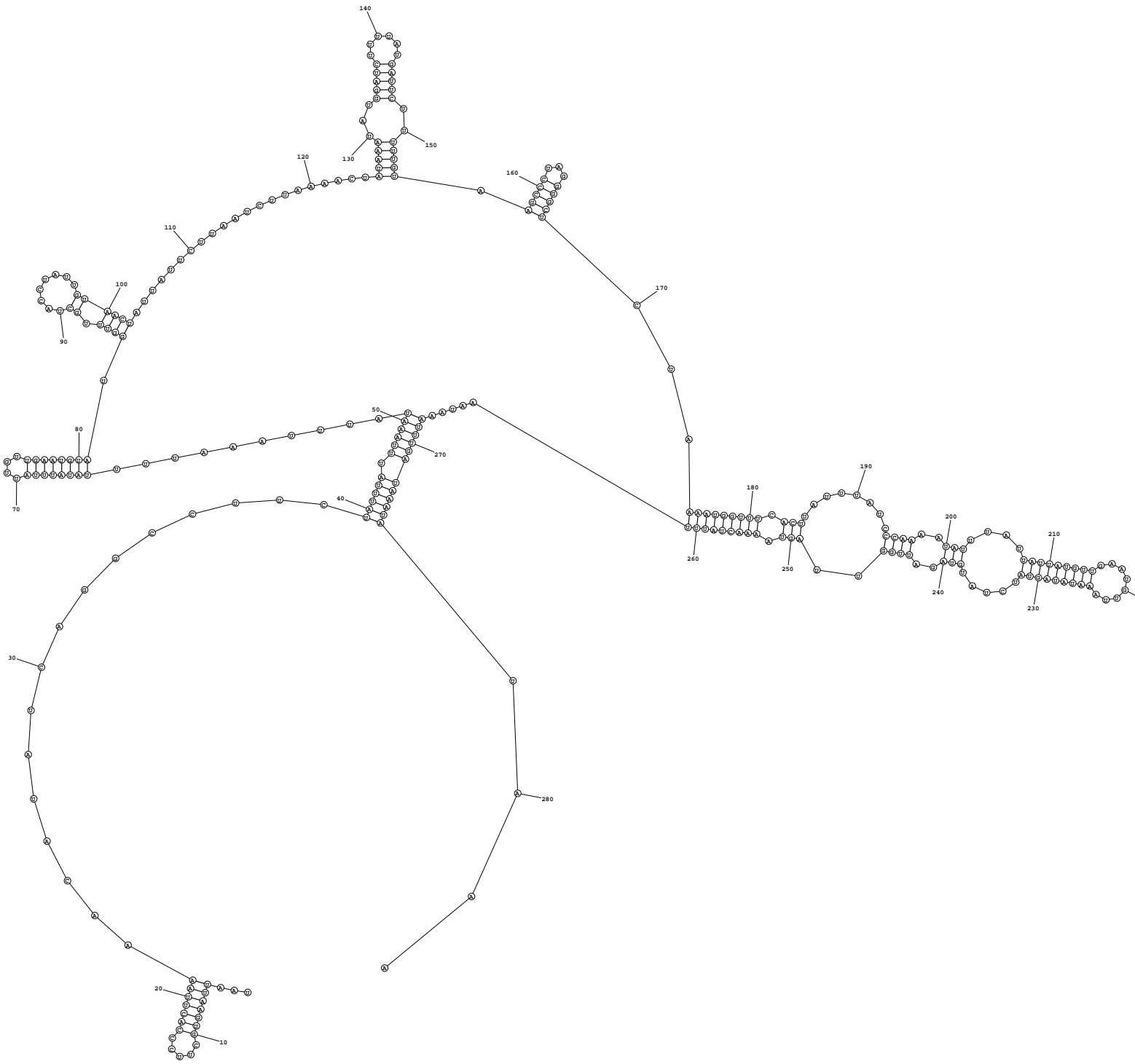

ENERGY = -46.8 04/23/26 18:02:37

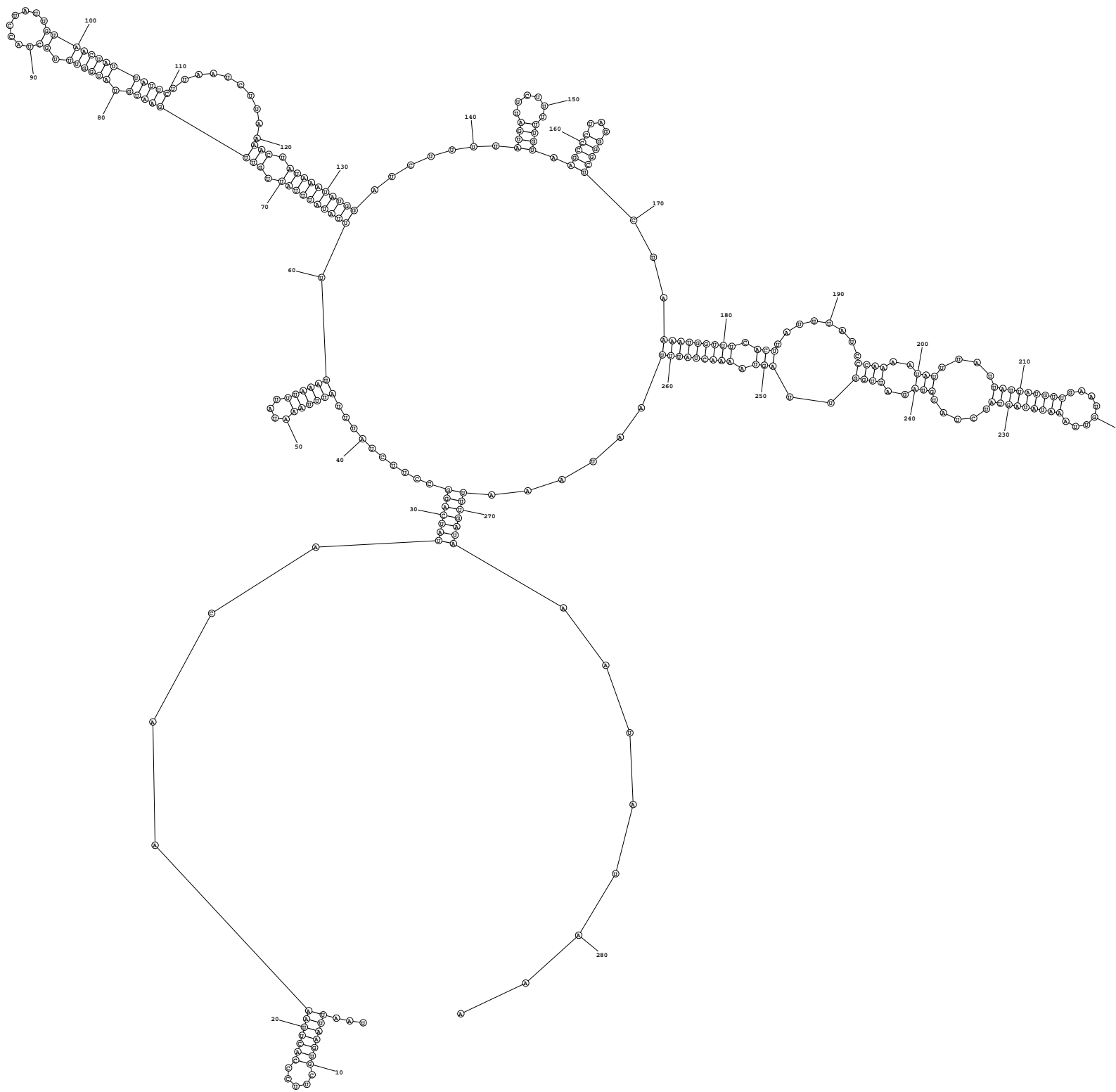

ENERGY = -46.7 04/23/26 18:02:37