

ENERGY = -156.3 03/28/26 03:17:02

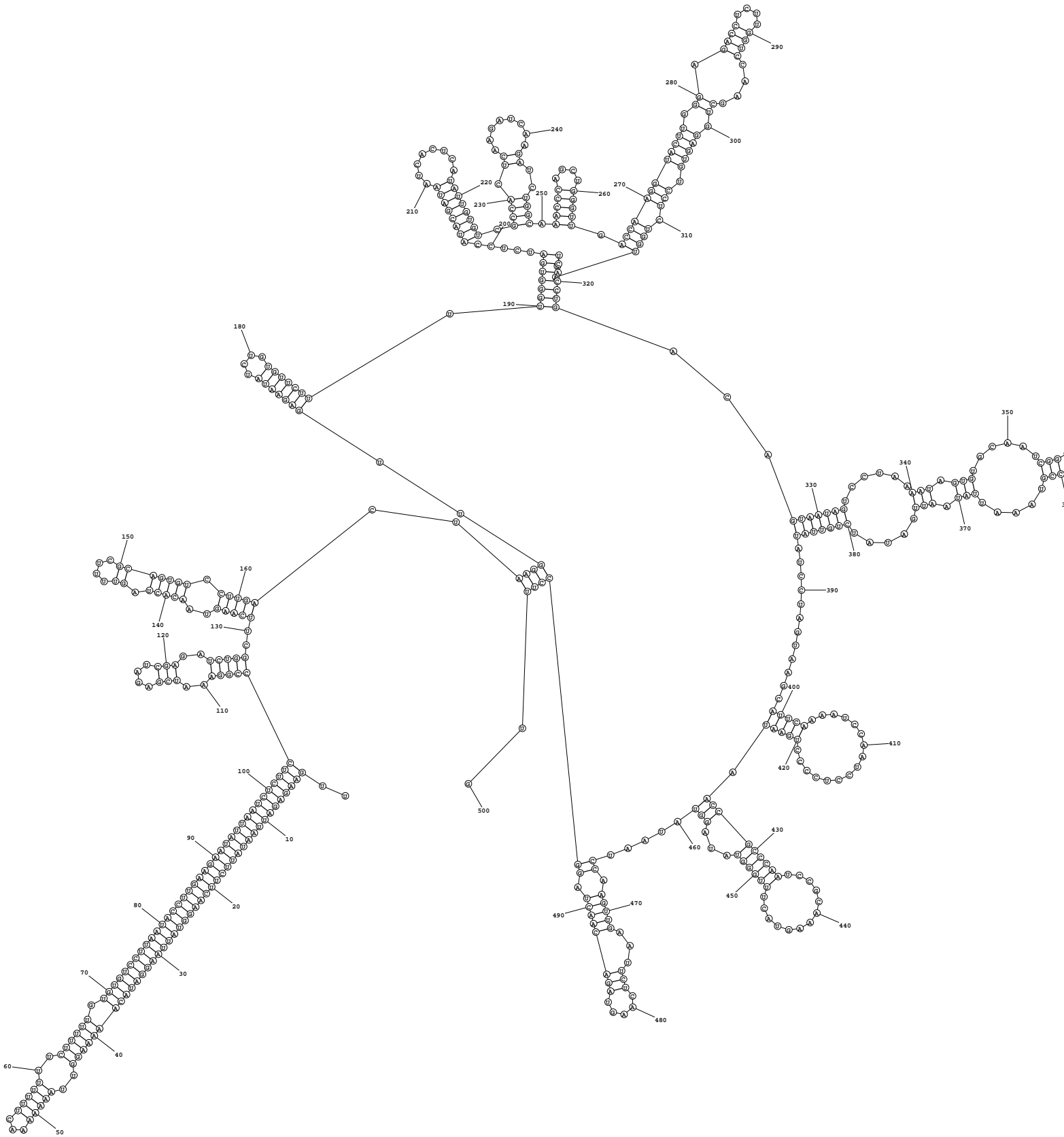

ENERGY = -156.2 03/28/26 03:17:02

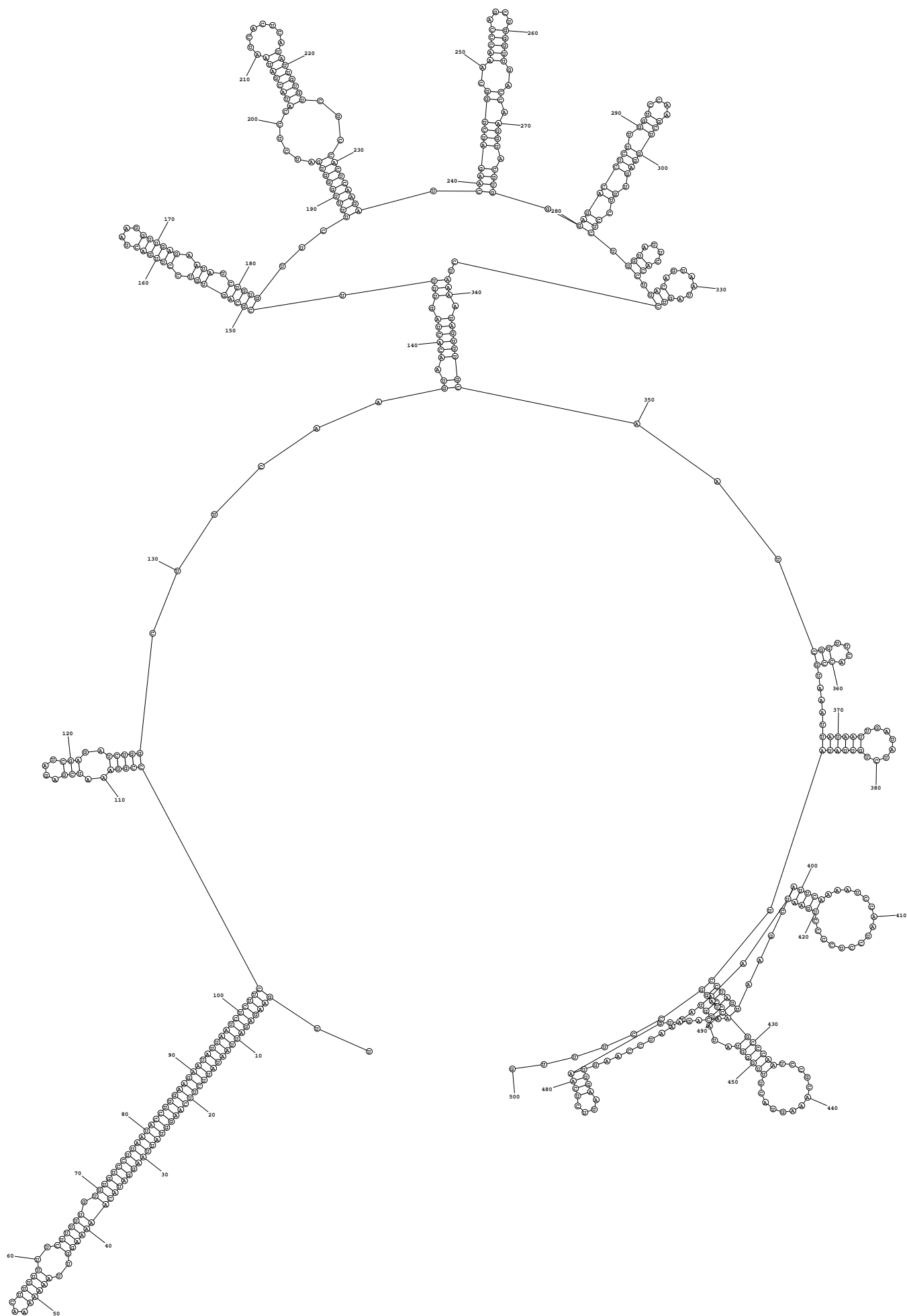

ENERGY = -155.9 03/28/26 03:17:02

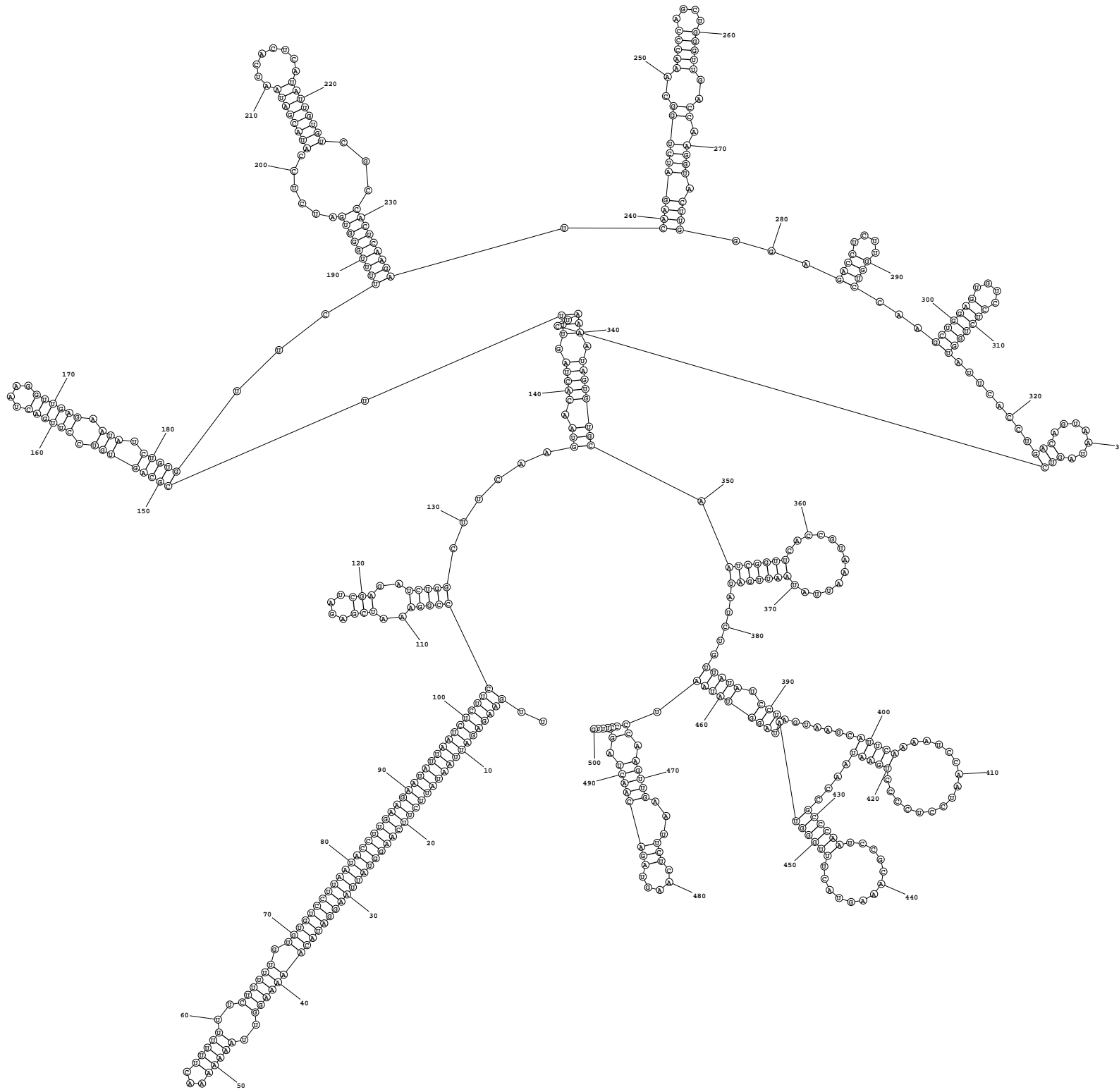

ENERGY = -155.3 03/28/26 03:17:02

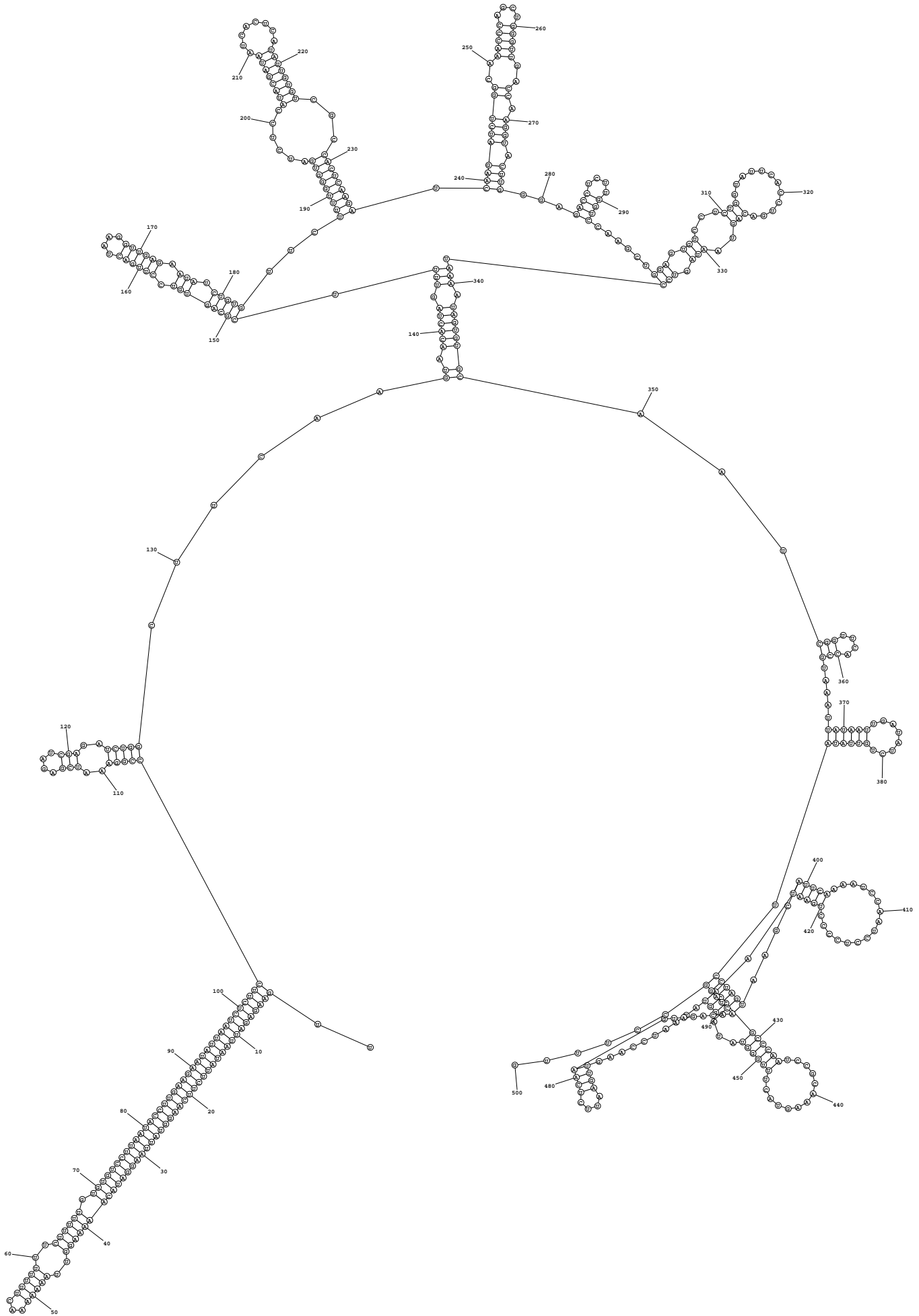

ENERGY = -155.0 03/28/26 03:17:02

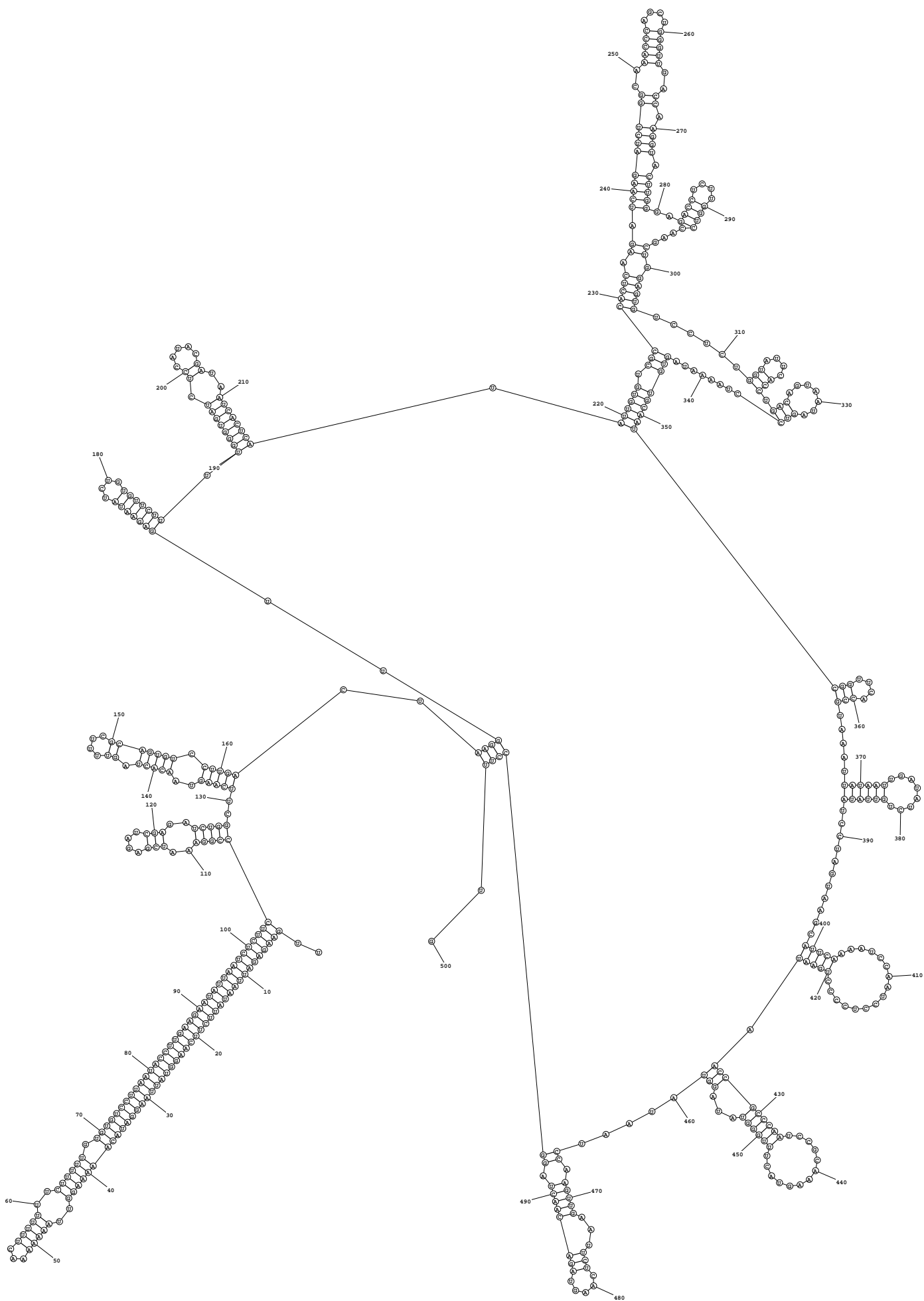

ENERGY = -154.9 03/28/26 03:17:02

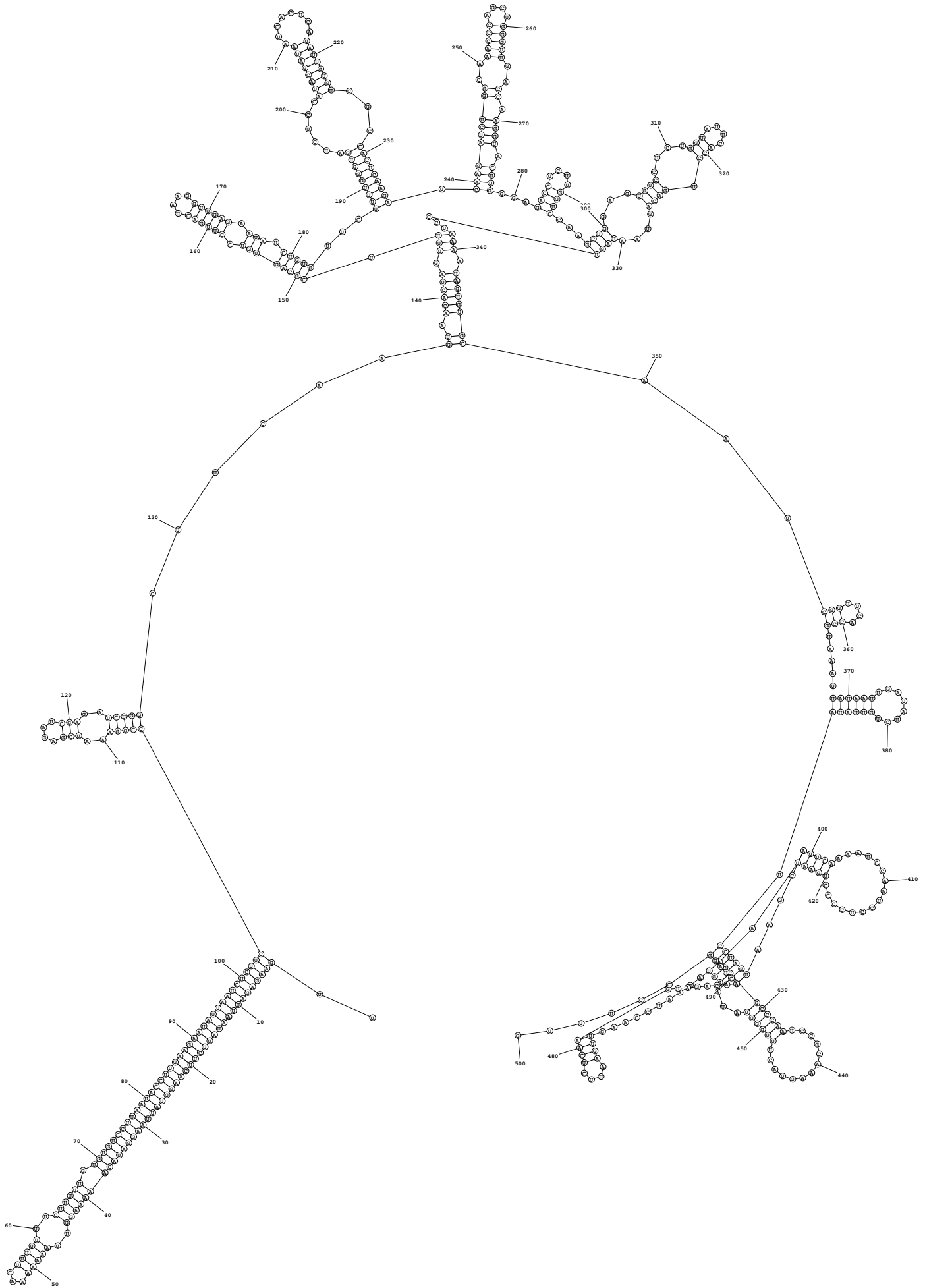

ENERGY = -154.8 03/28/26 03:17:02

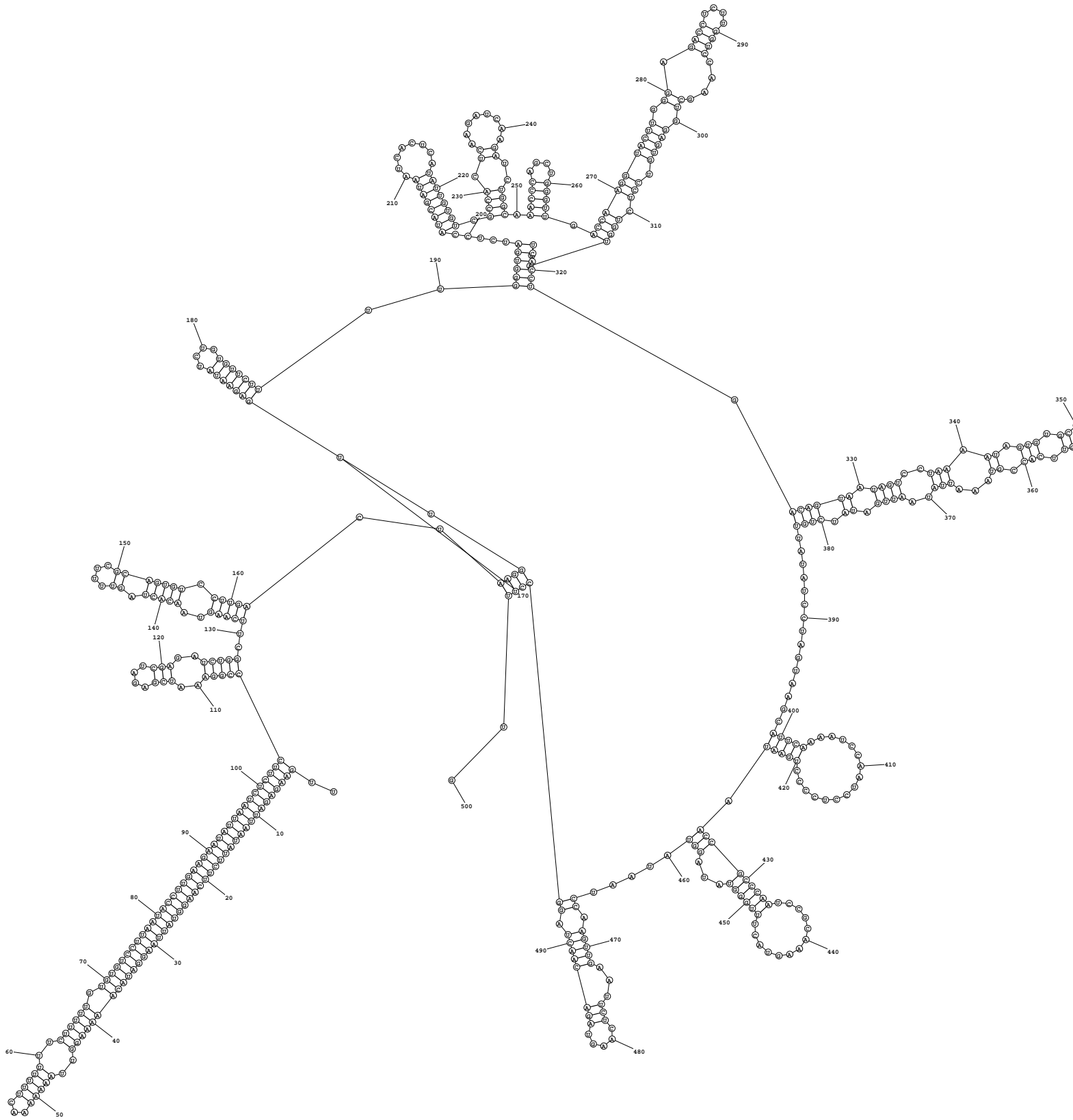

ENERGY = -154.6 03/28/26 03:17:02

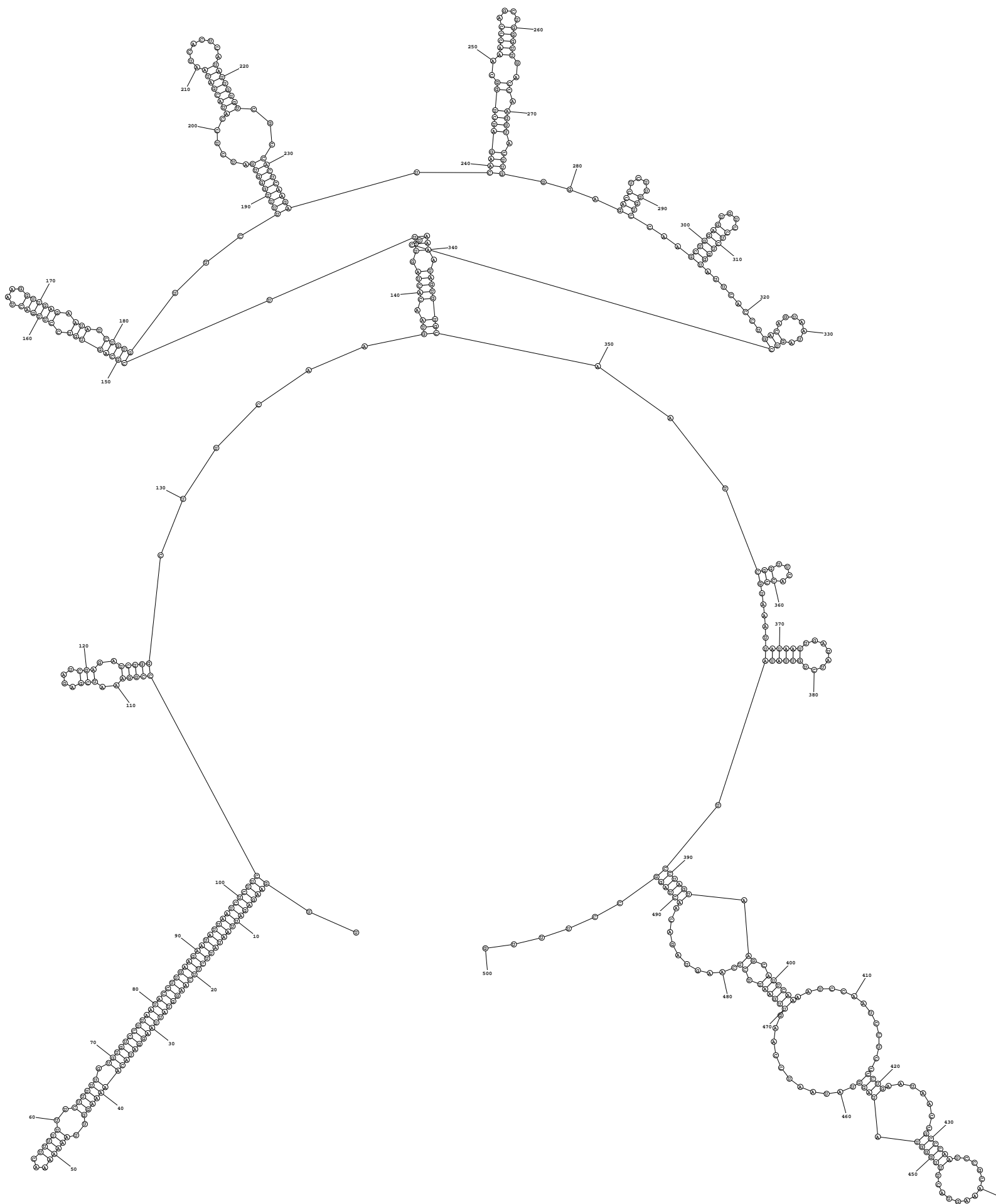

ENERGY = -154.5 03/28/26 03:17:02



ENERGY = -154.5 03/28/26 03:17:02

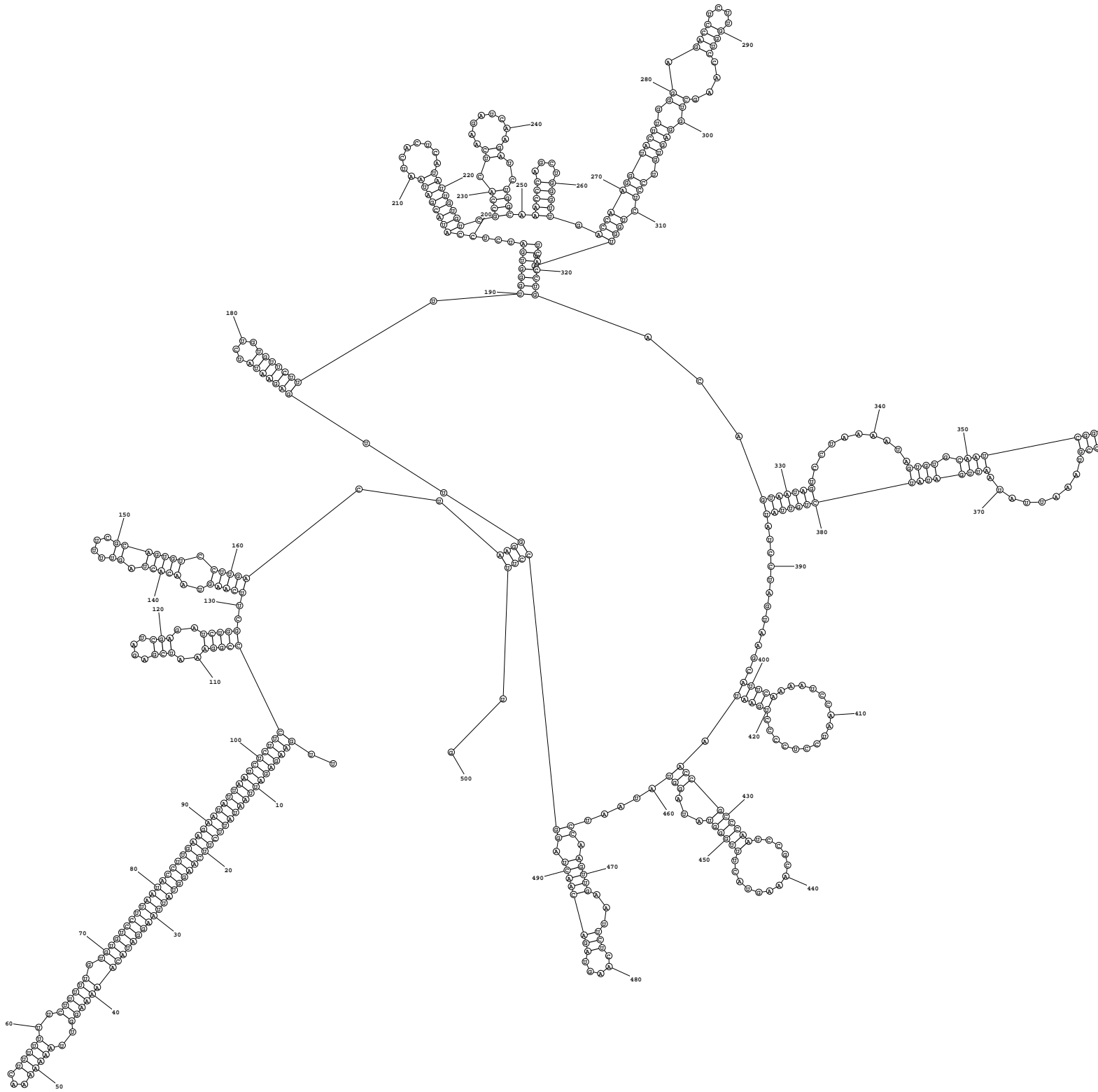

ENERGY = -154.5 03/28/26 03:17:02

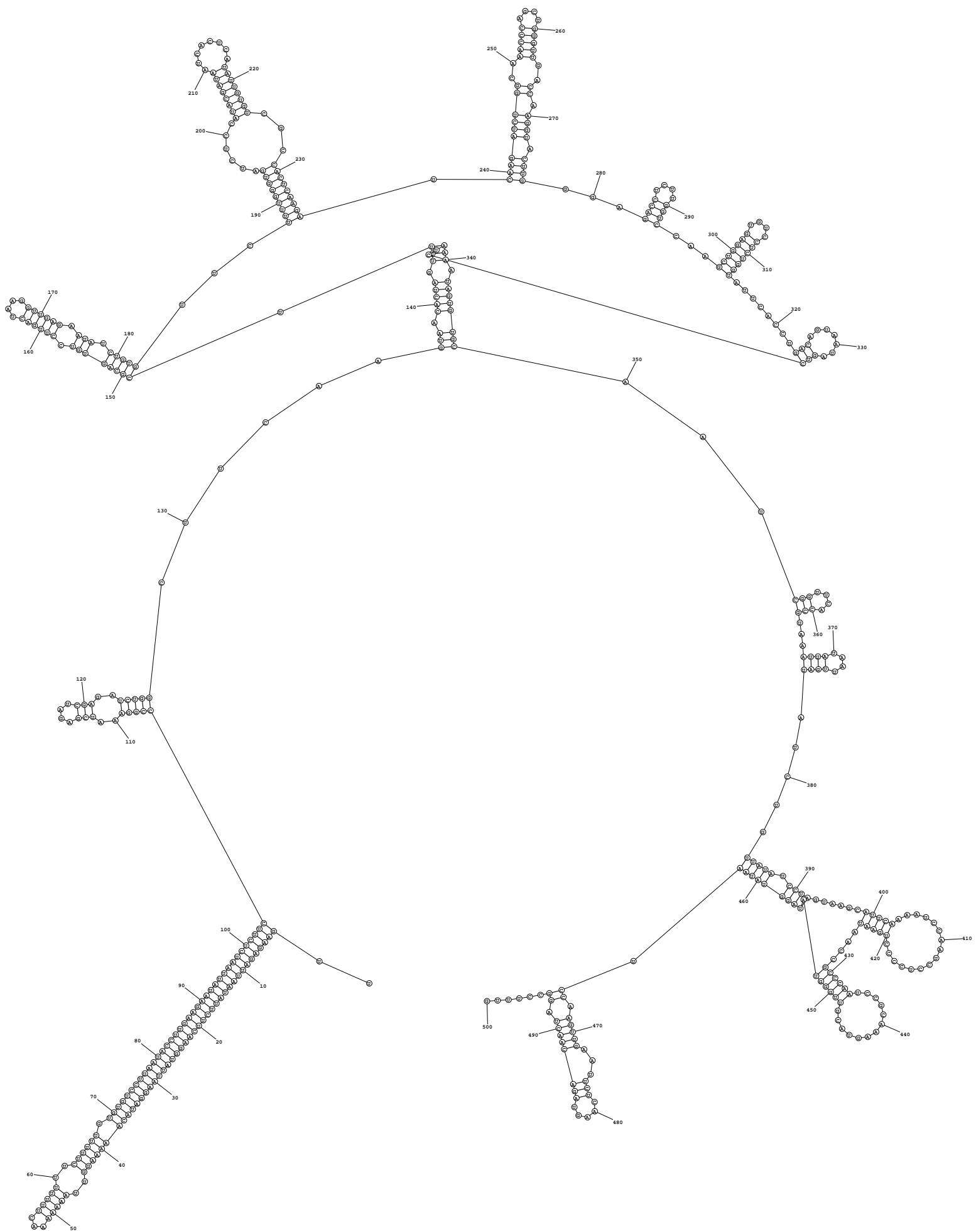

ENERGY = -154.3 03/28/26 03:17:02

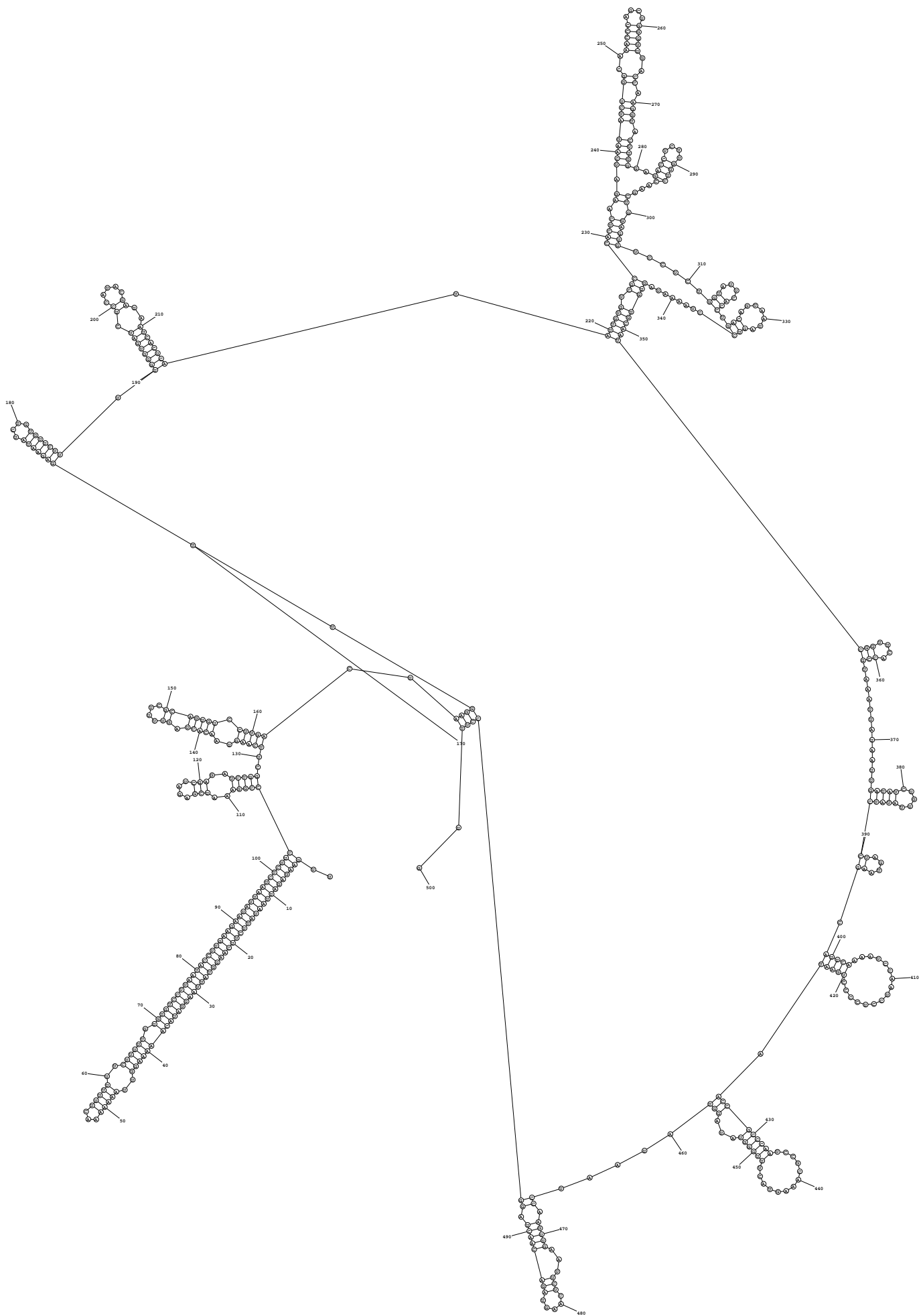

ENERGY = -154.3 03/28/26 03:17:02

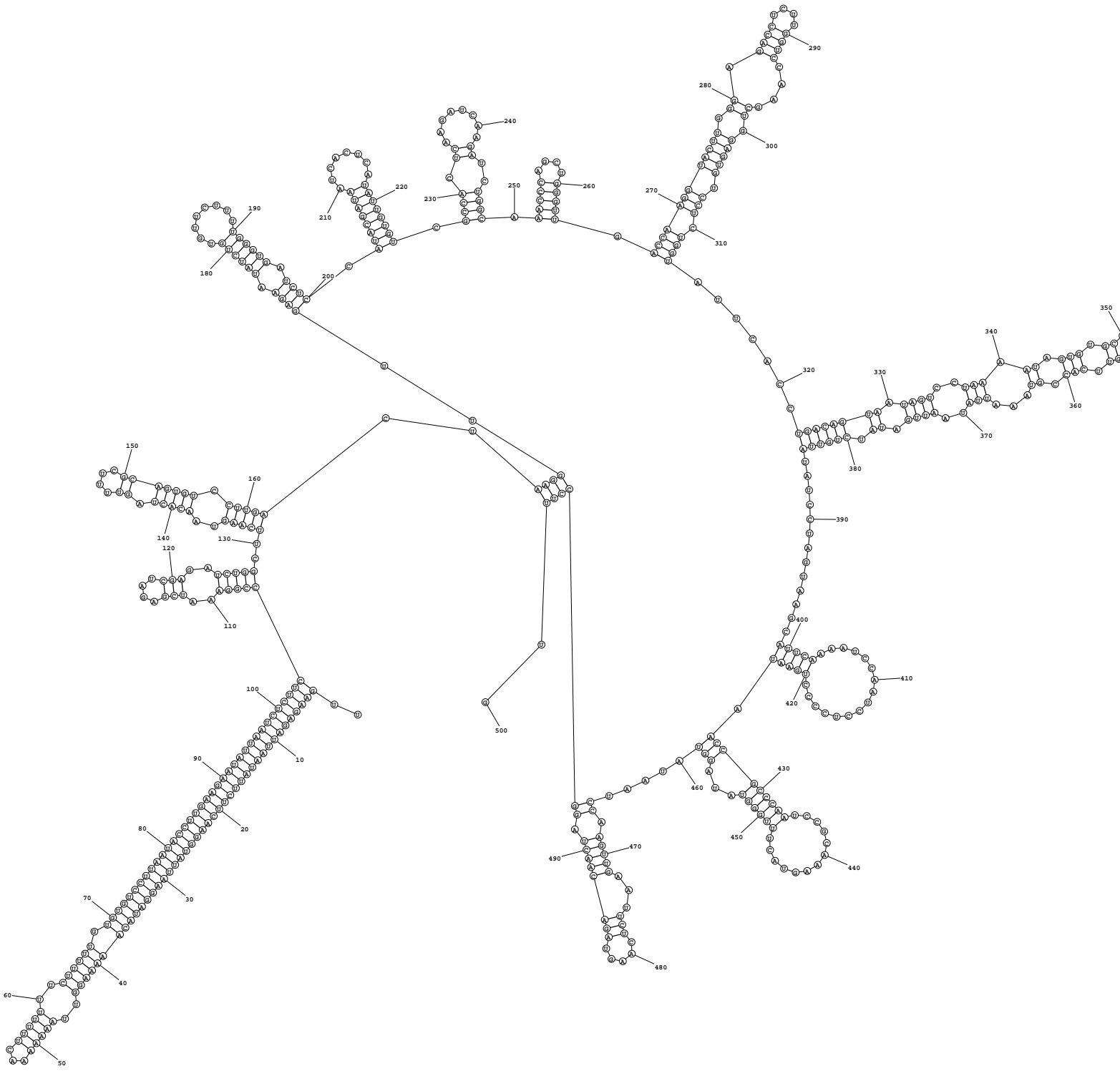

ENERGY = -154.2 03/28/26 03:17:02

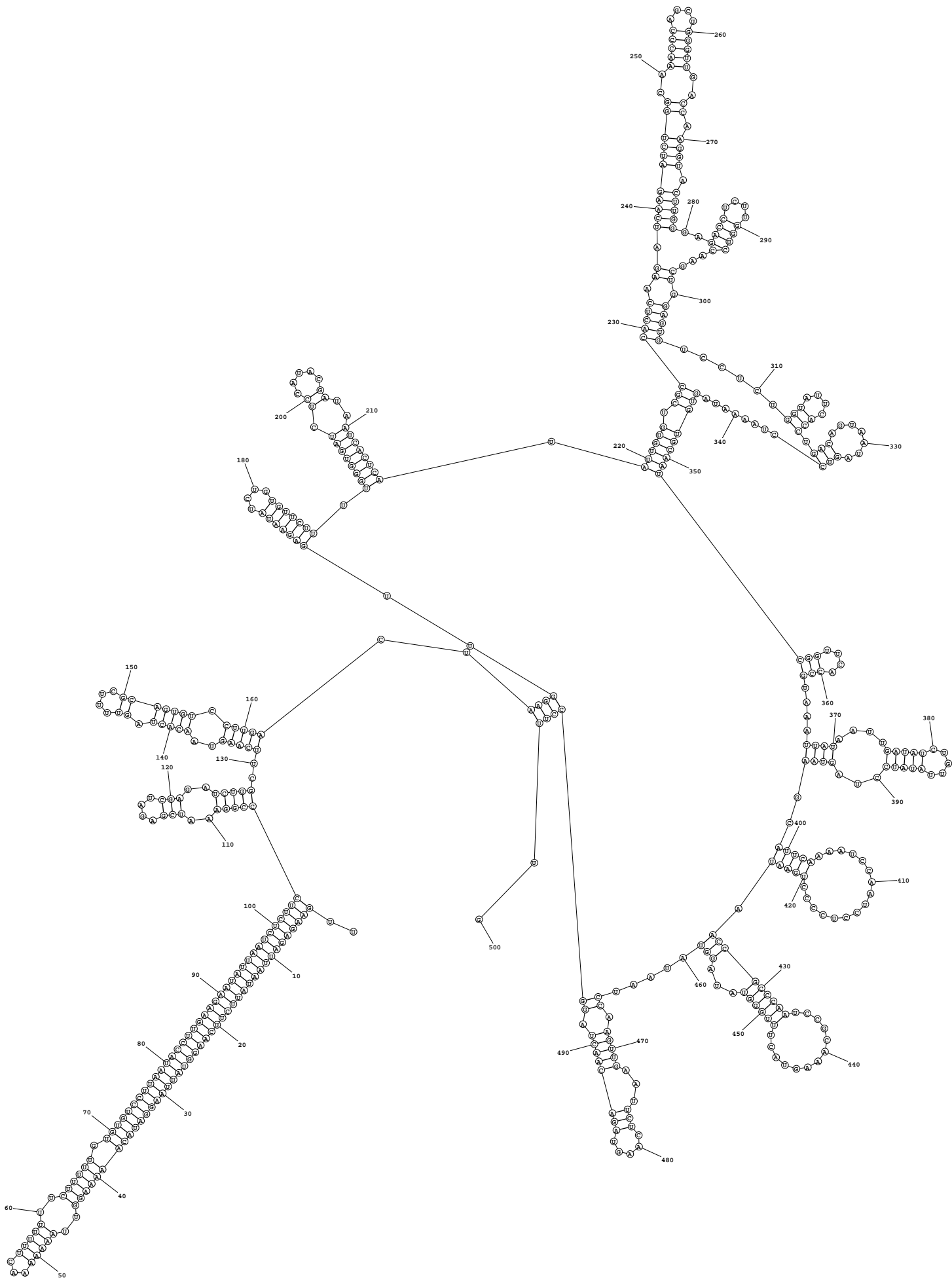

ENERGY = -153.9 03/28/26 03:17:02

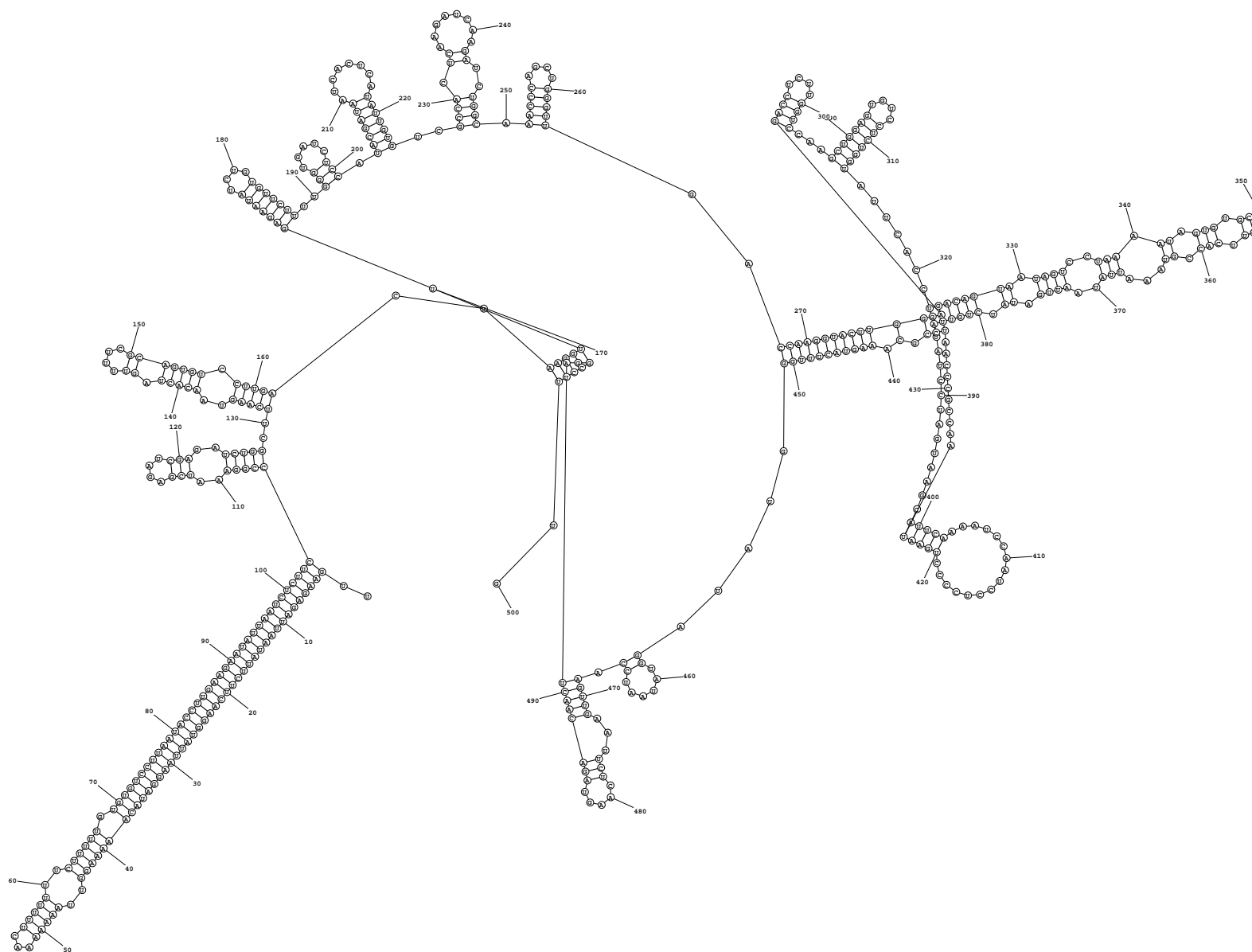

ENERGY = -153.9 03/28/26 03:17:02

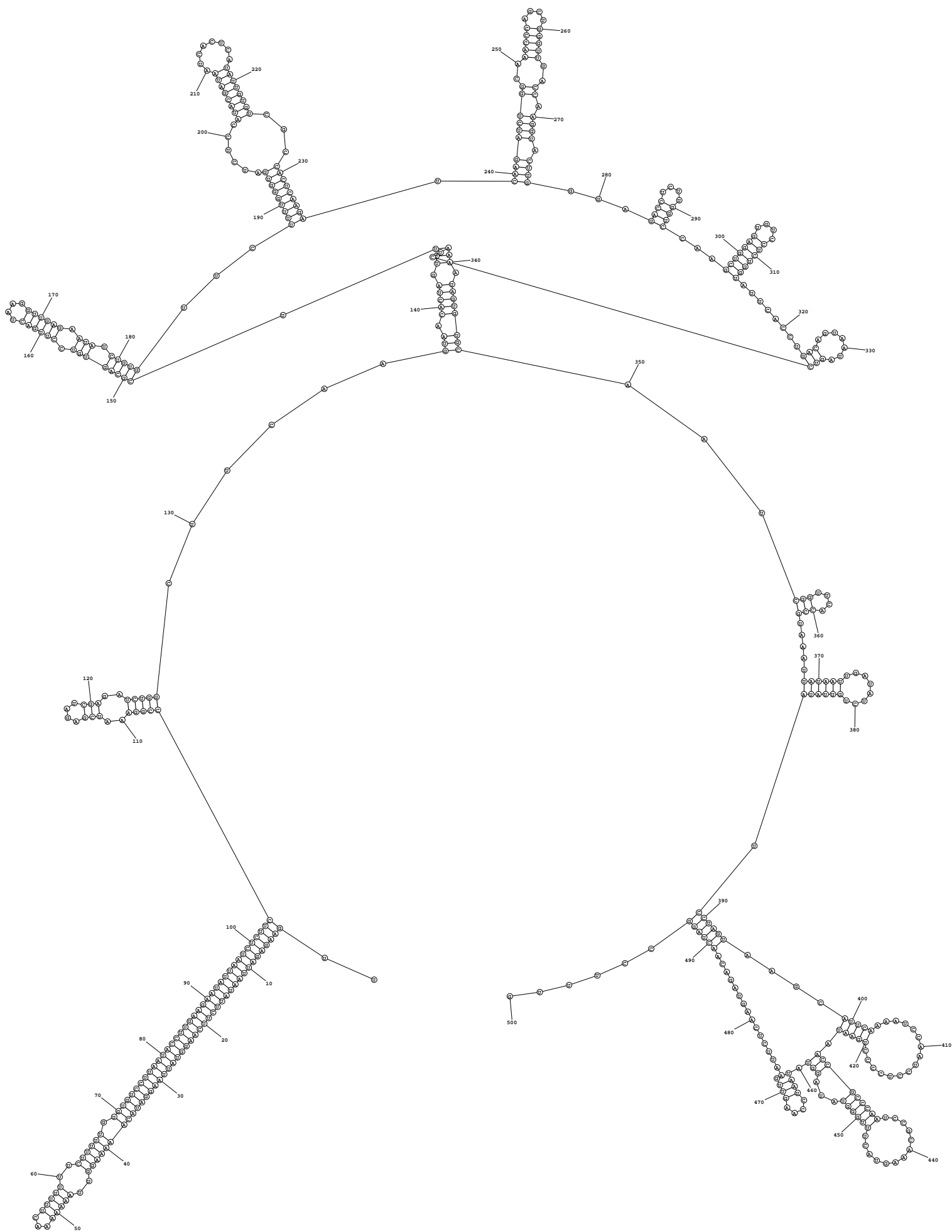

ENERGY = -153.9 03/28/26 03:17:02

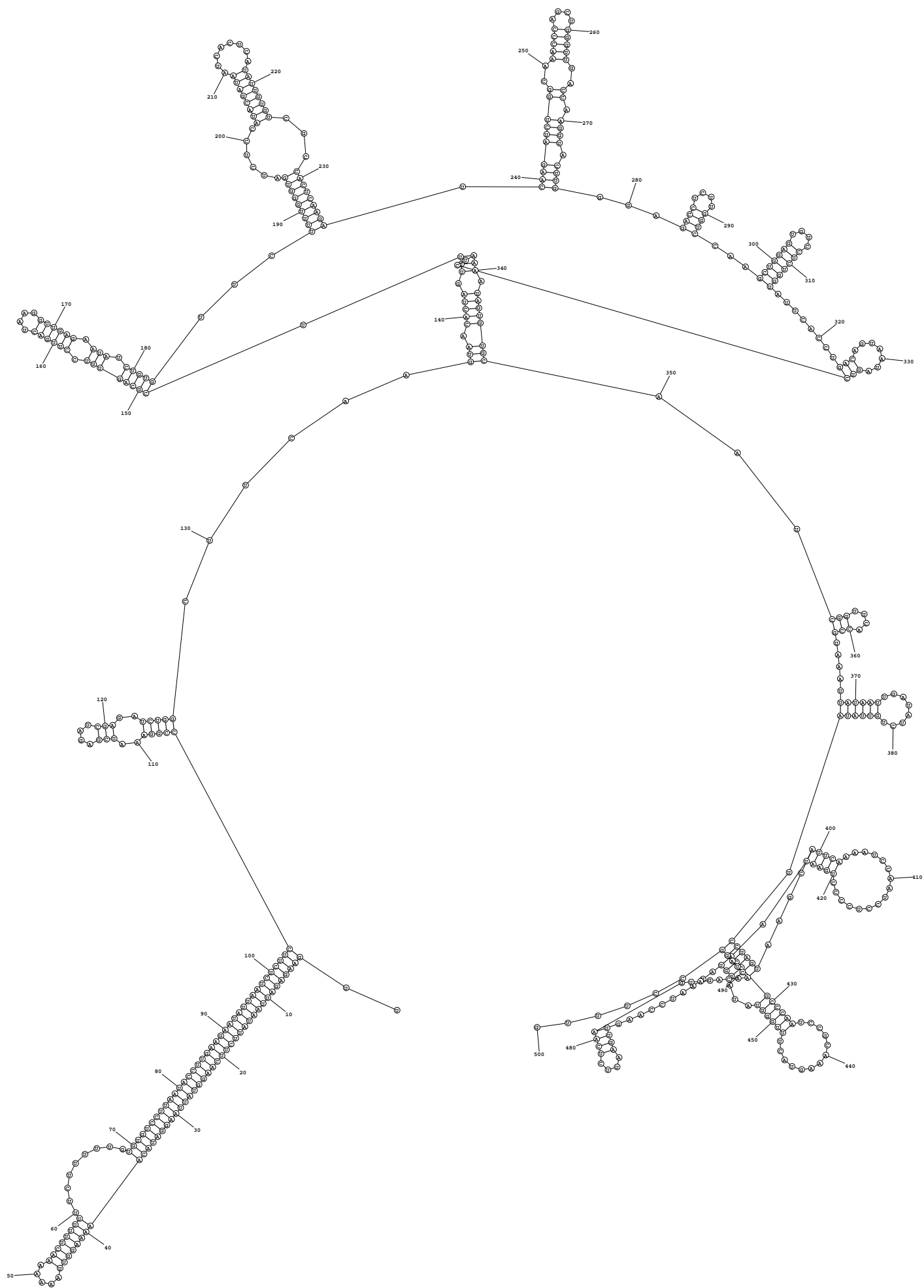

ENERGY = -153.9 03/28/26 03:17:02

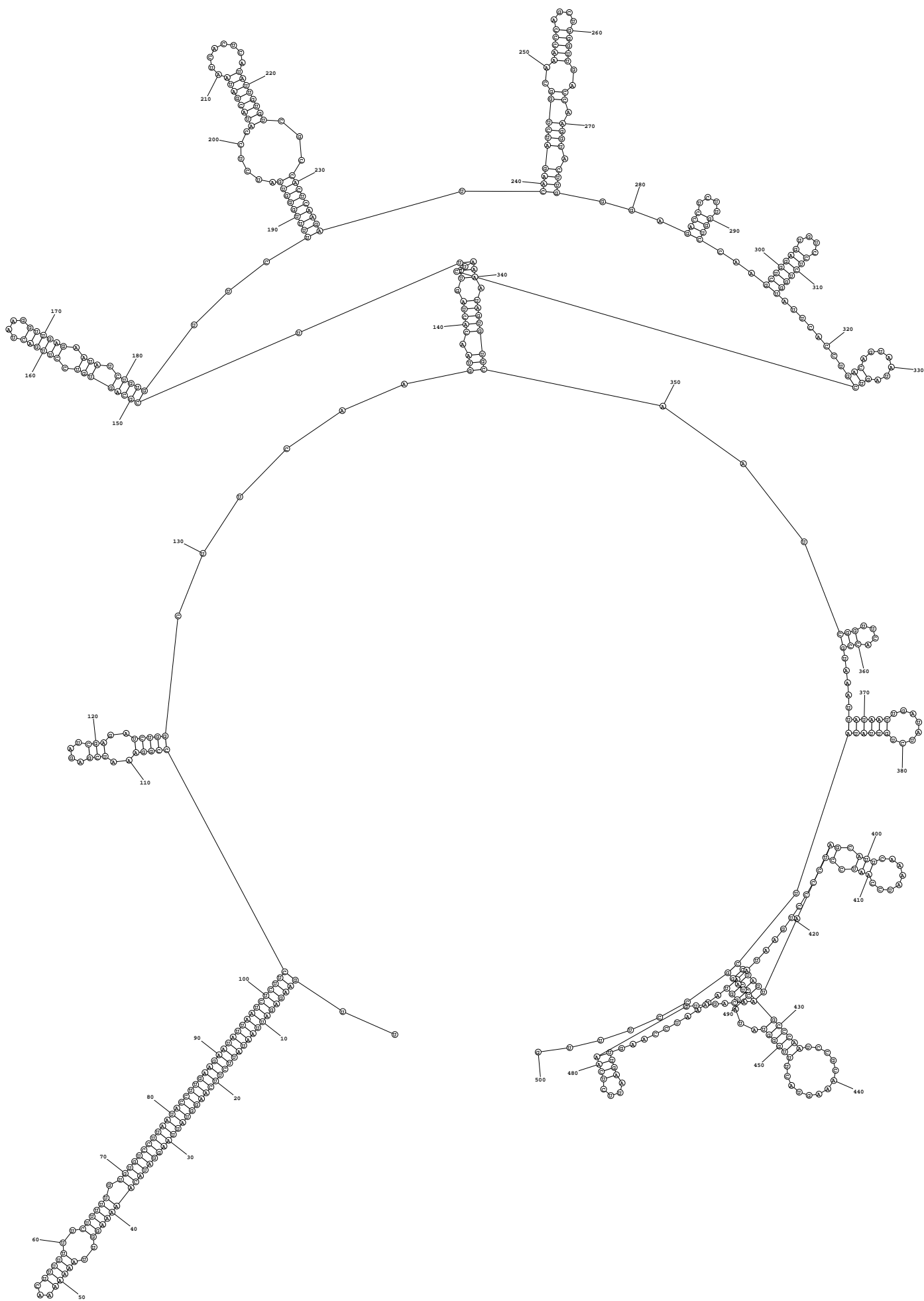

ENERGY = -153.8 03/28/26 03:17:02

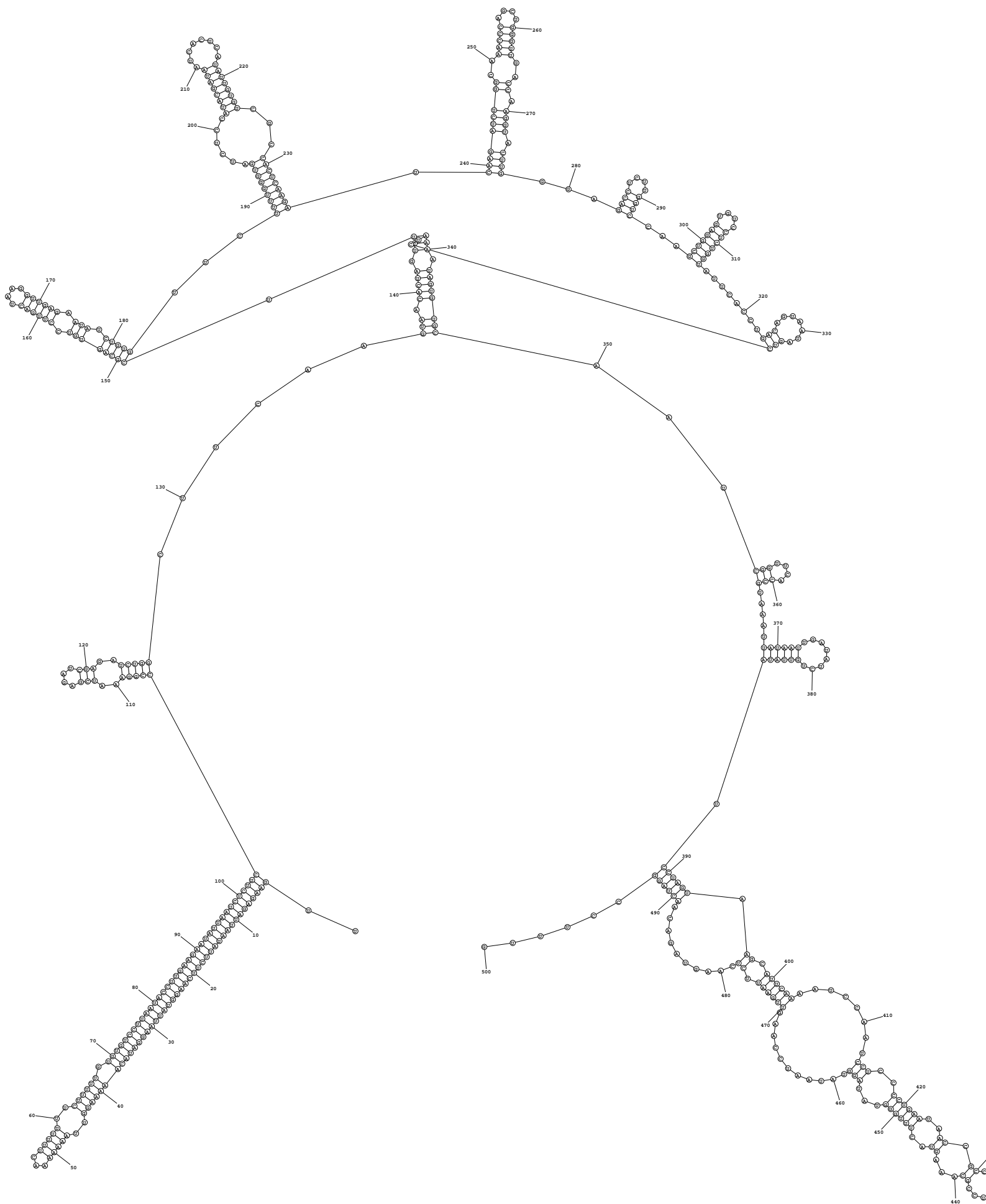

ENERGY = -153.8 03/28/26 03:17:02